



MARVEL

76254





Get excited about our new packaging!

We're switching from plastic to paper-based packaging. That's why you might find a mix of paper and plastic in our boxes!

Nos nouveaux emballages vous emballeront !

Nous passons des emballages en plastique aux emballages à base de papier. C'est pourquoi vous pourriez trouver un mélange de papier et de plastique dans nos boîtes !

¡Te presentamos nuestros nuevos empaques!

Estamos sustituyendo las bolsas de plástico por bolsas con base de papel. ¡Por eso, puedes encontrar una mezcla de papel y de plástico en nuestras cajas!

[LEGO.com/sustainable-packaging](https://www.lego.com/sustainable-packaging)



BUILDER



Apple and the Apple logo are trademarks of Apple Inc., registered in the U.S. and other countries and regions. App Store is a service mark of Apple Inc. Google Play and the Google Play logo are trademarks of Google LLC. Tencent and the Tencent logo are trademarks of Tencent Inc.

LEGO.com/devicecheck

EN Ask parents' permission before going online | DE Eltern um Erlaubnis bitten, bevor du online gehst | FR Demande l'autorisation d'un parent avant d'aller en ligne | IT Chiedi il permesso ai tuoi genitori prima di andare online | ES Pídeles permiso a tus papás antes de conectarte a Internet | PT Peça autorização aos pais antes de acederes online | JA オンラインになる前にほご者の方のきよかをもらおう | ZH 上网前应先征得父母的同意 | KO 온라인 접속 전에 보호자 동의가 필요합니다 | RU Спроси разрешения у родителей, прежде чем заходить в интернет | PL Poproś rodziców o zgodę, zanim wejdiesz do Internetu | CS Než půjdeš na internet, požádej rodiče o svolení | SK Než pôjdeš na internet, vypýtaj si povolenie od rodičov | HU Kérj szülői engedélyt, mielőtt online csatlakoznál! | RO Cere permisiunea părinților înainte de a te conecta online | BG Поискайте разрешение от родител, преди да влезете онлайн | LV Pirms došanās tiešsaistē palūdz atļauju vecākiem | ET Enne Interneti kasutamist küsi vanematelt luba | LT Prieš prisijungdami prie interneto, atsislaukite tėvų

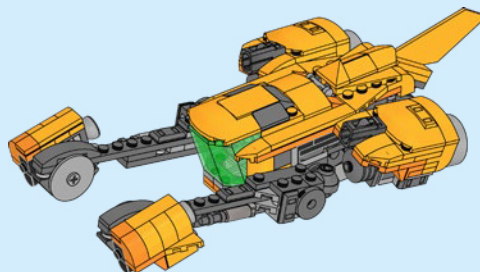
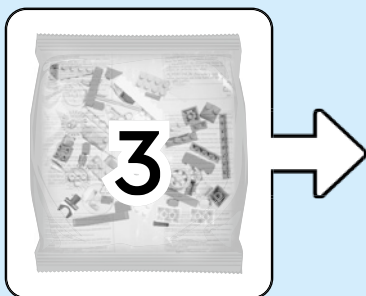
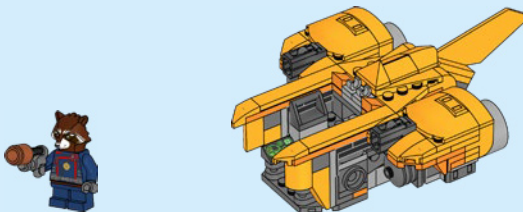
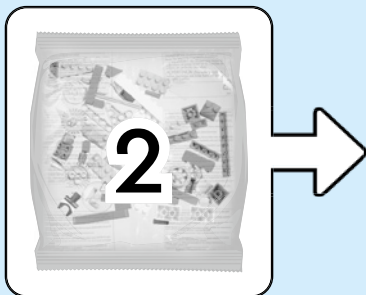
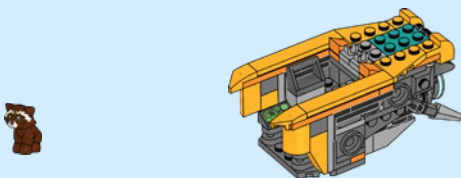
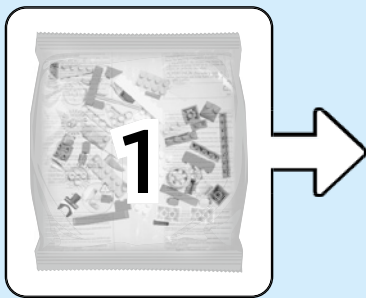



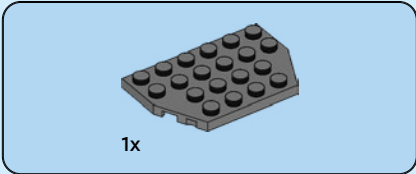
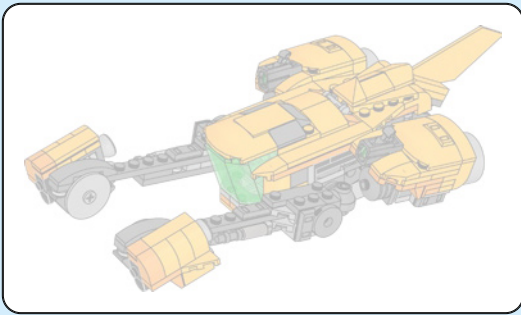

1

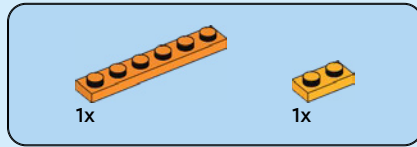
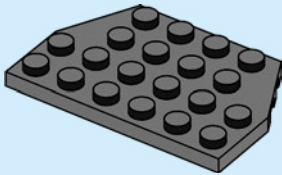

2

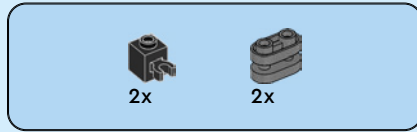
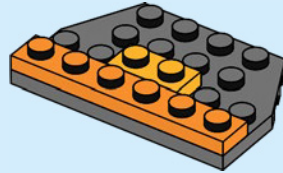

3

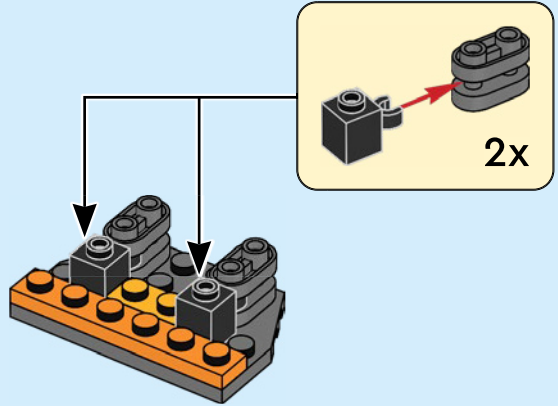



2x

4

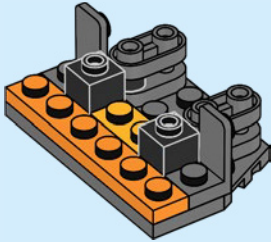

1x



2x

5

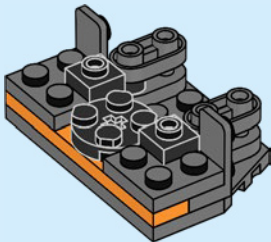

2x

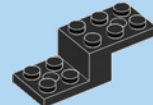

1x

6

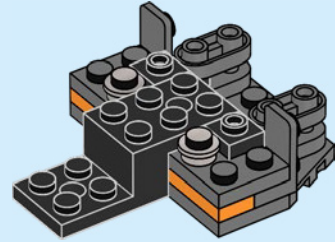

2x

7

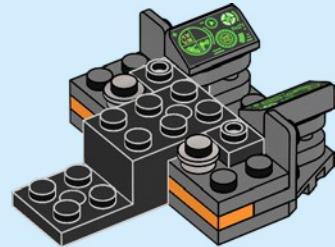



2x

8

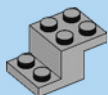
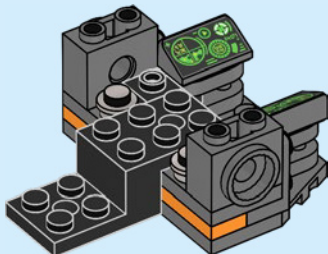

2x

9

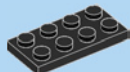
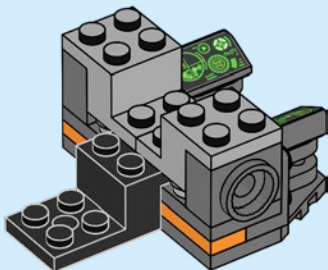

1x



1x

10

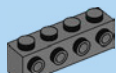
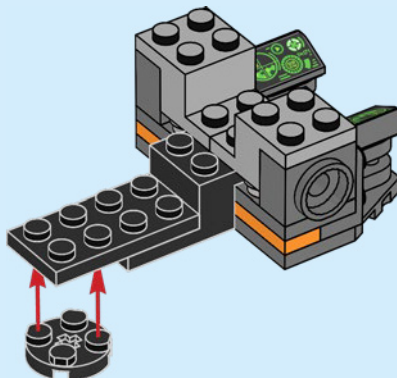

2x



1x

11

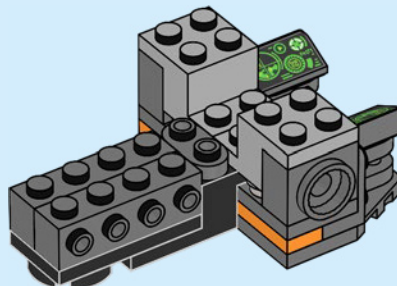

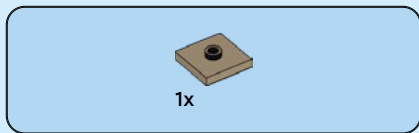

12

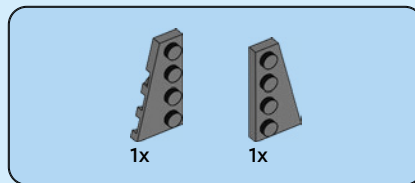
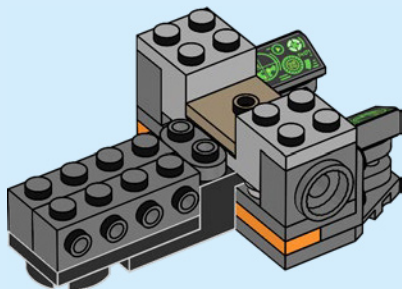

14

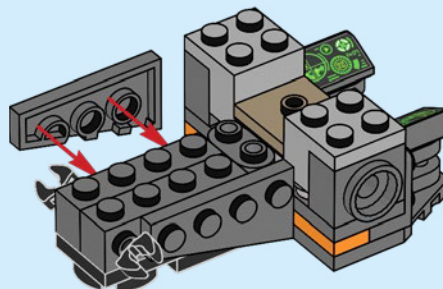

13

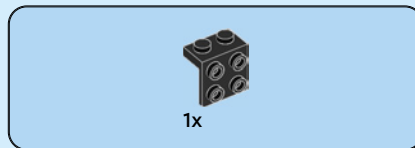
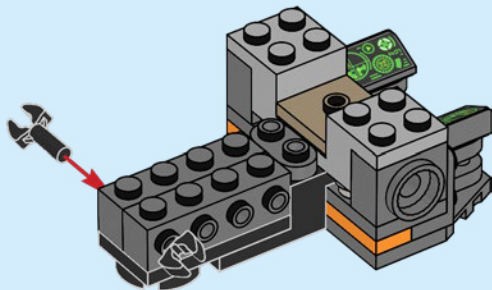

15

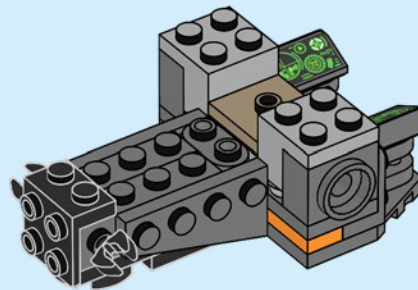

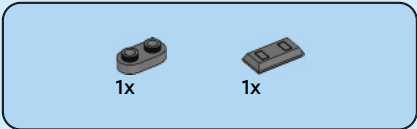

16

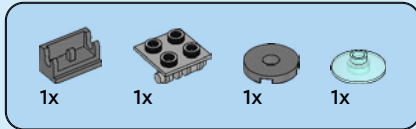
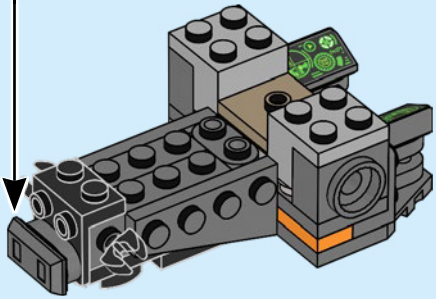
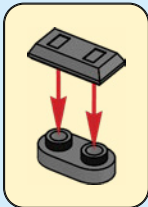

17

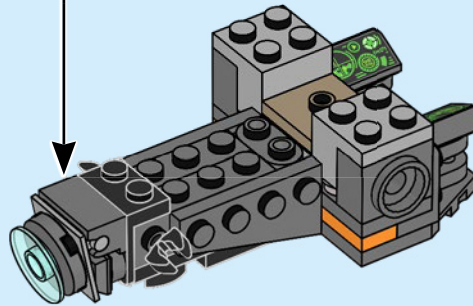
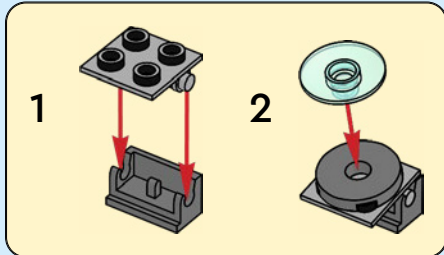

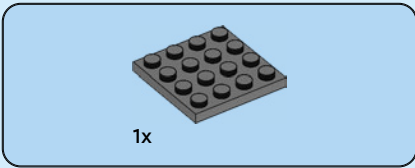

18

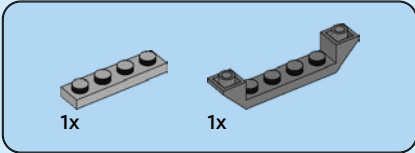
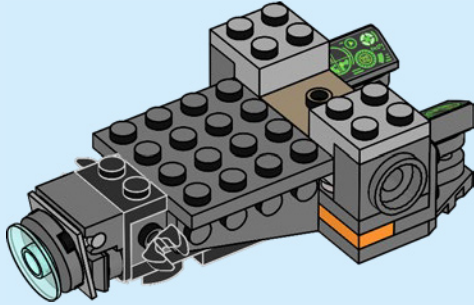

19

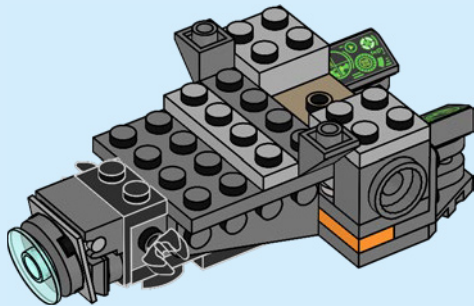

20

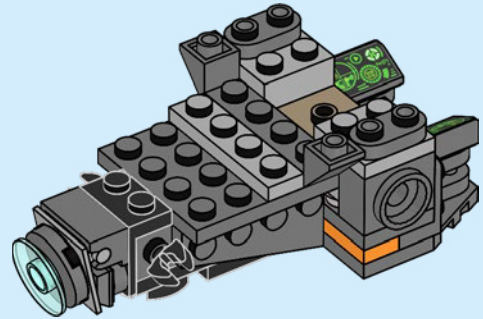



2x

21

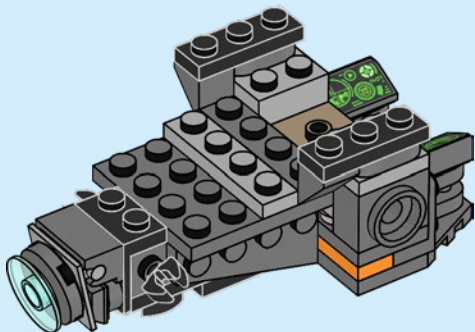

1x

22

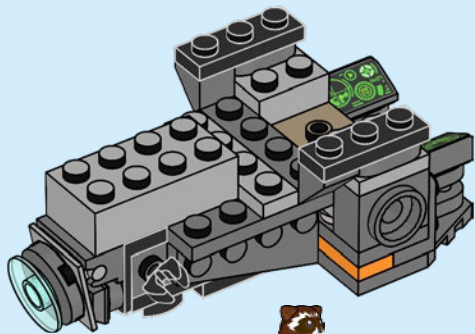

2x



2x

23

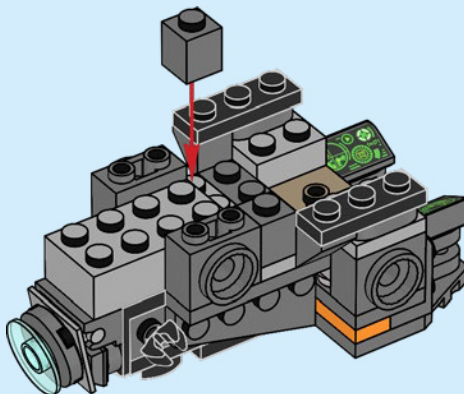



1x



2x

24

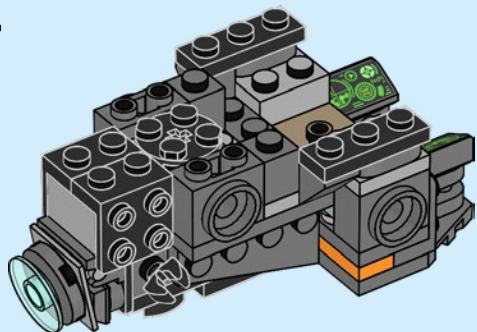

2x



2x

25

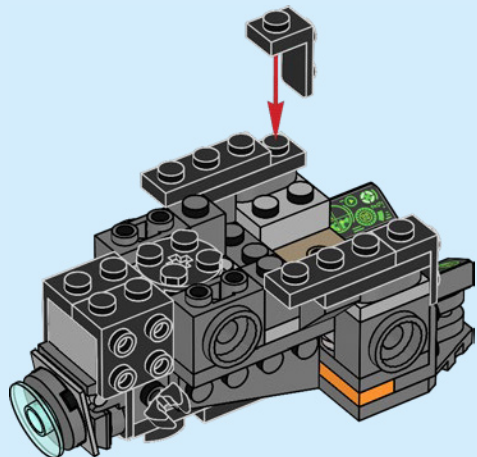

2x

26

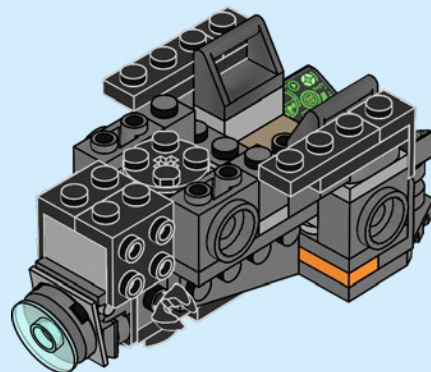



1x



1x

27

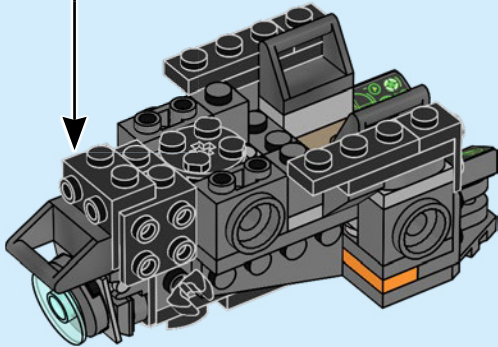
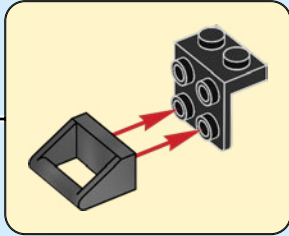

2x

28

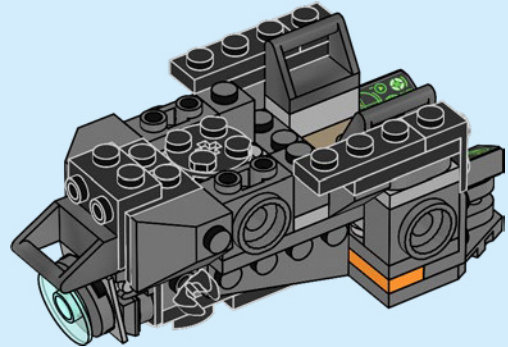

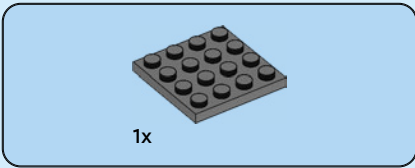

29

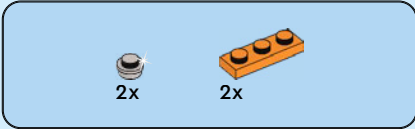
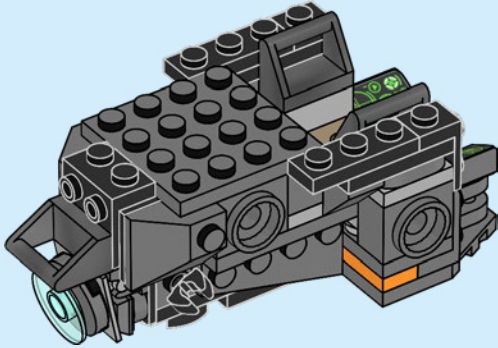

30

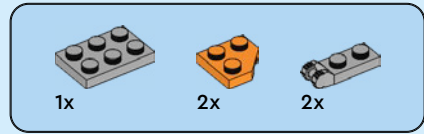
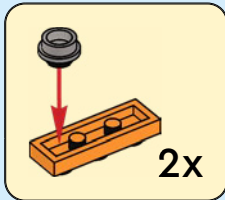
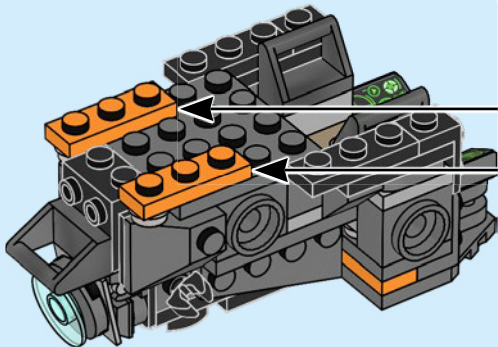

31

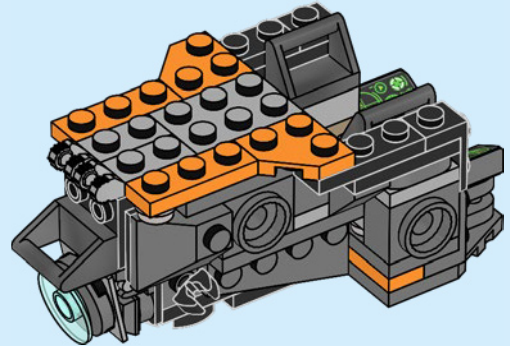

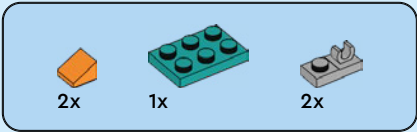

32

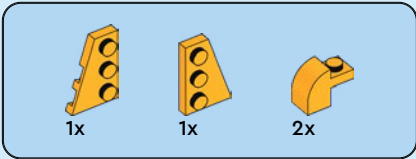
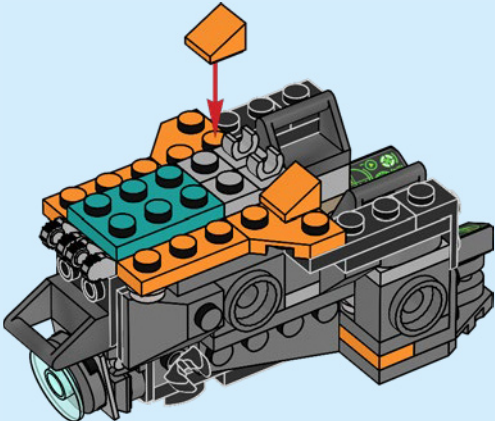

33

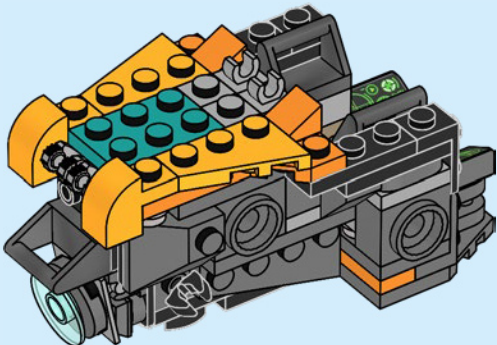

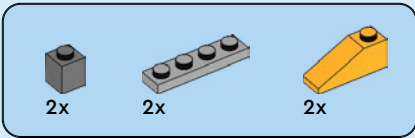

34

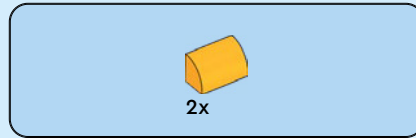
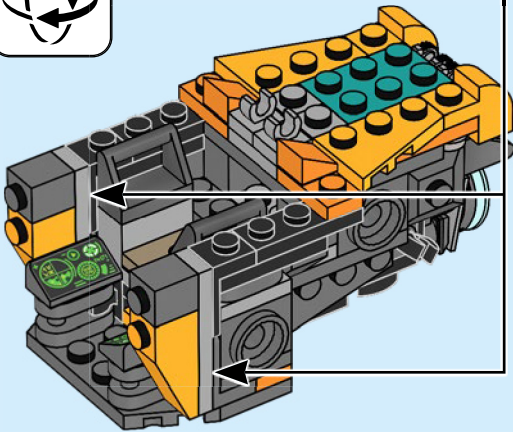
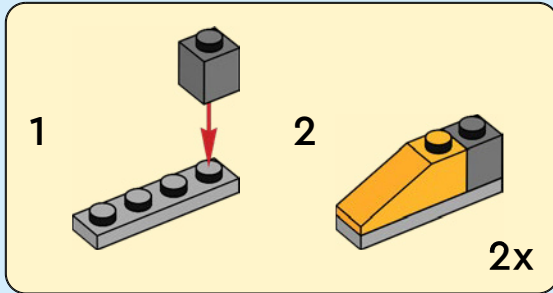

35

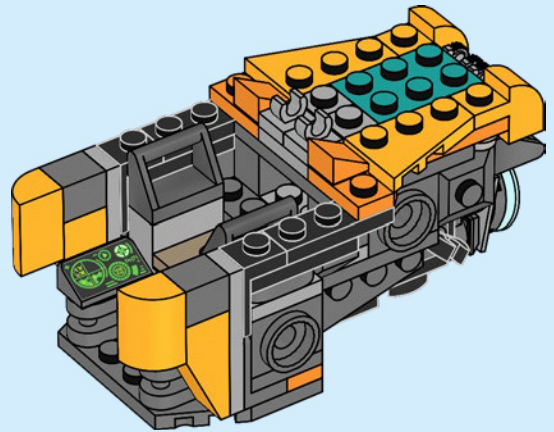

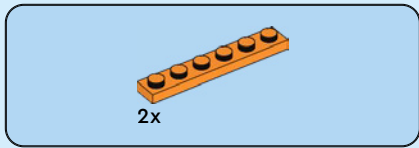

36

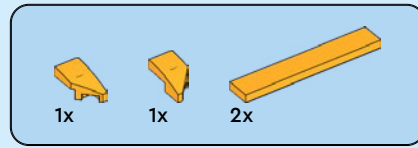
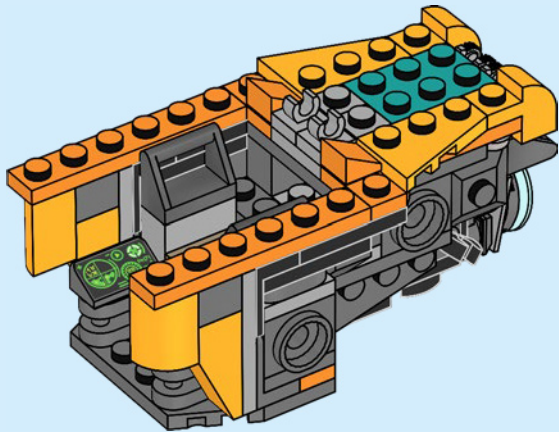

37

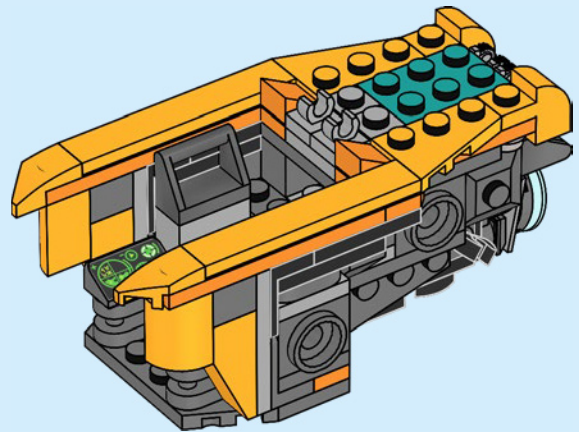

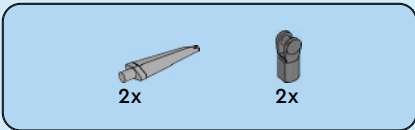

38

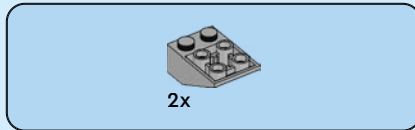
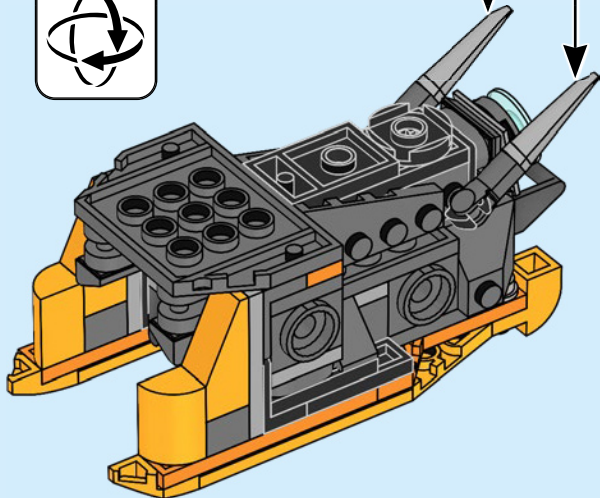
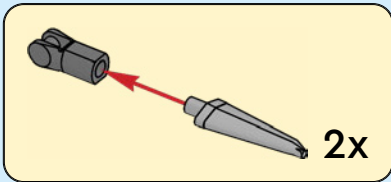

39

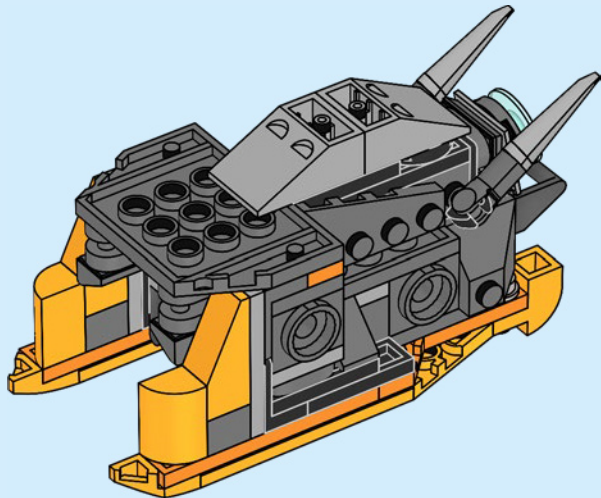

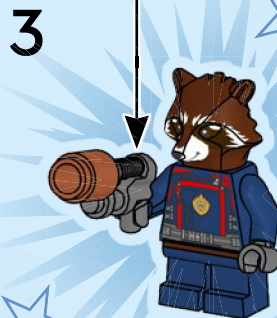
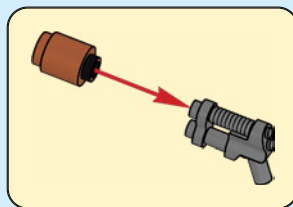
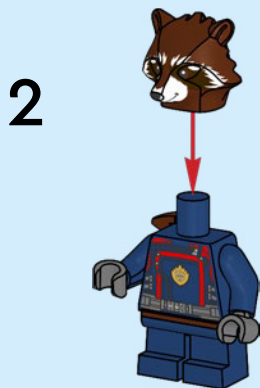
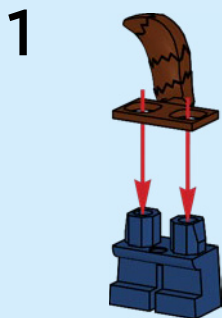

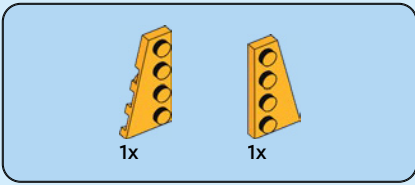

40

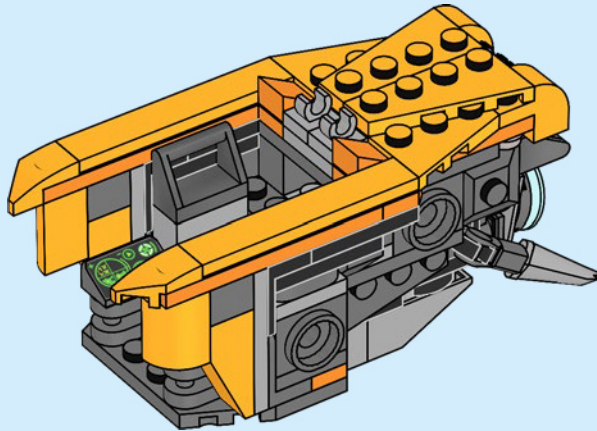

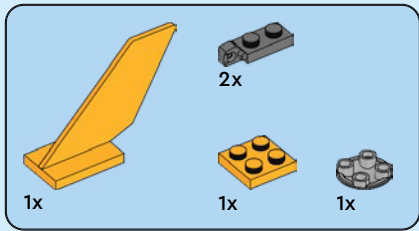

41

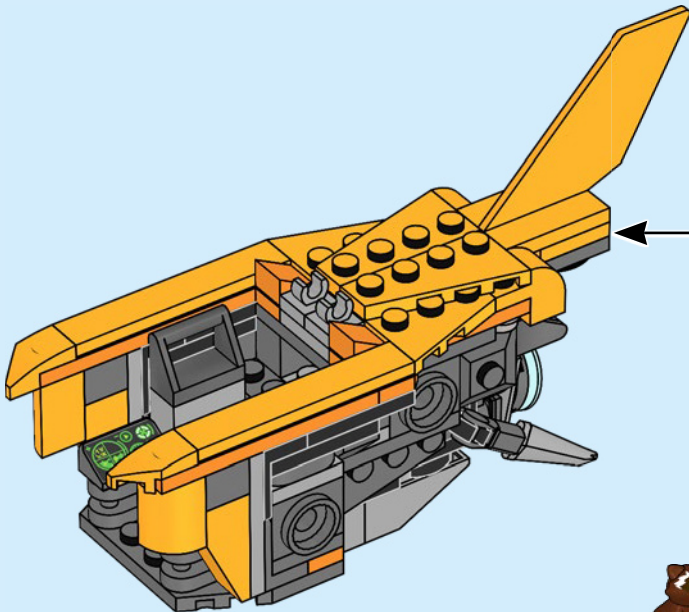
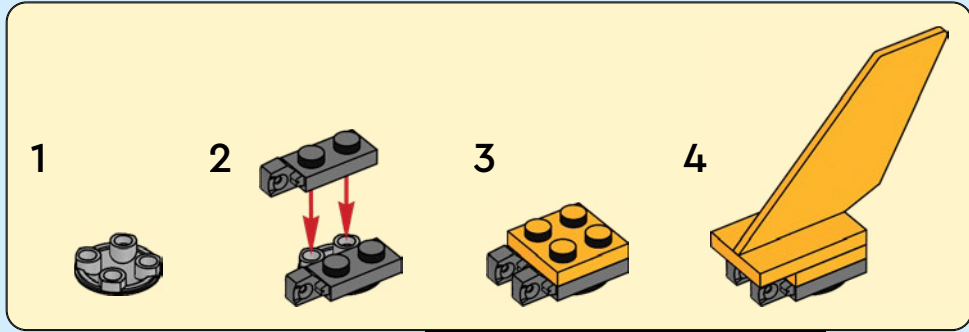

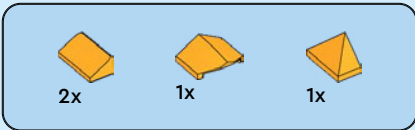

42

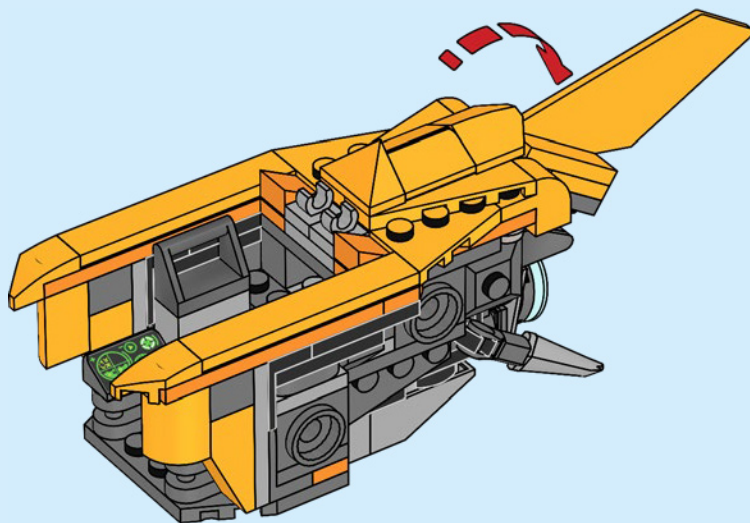

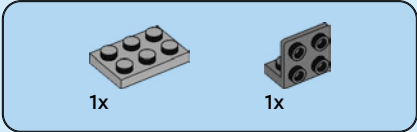
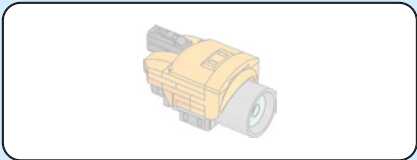

43

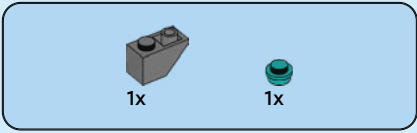
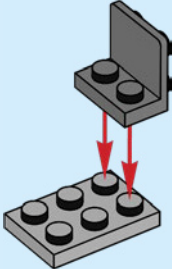

44

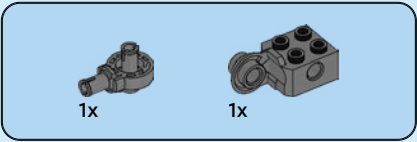
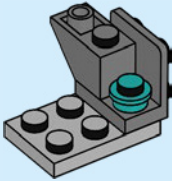

45

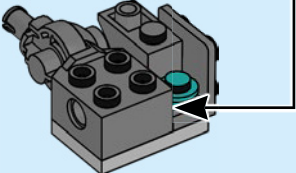
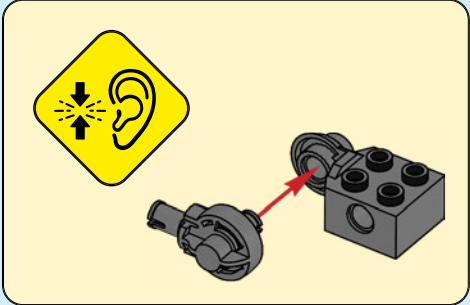



2x

46

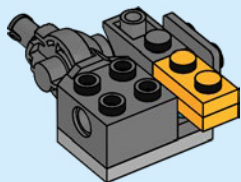
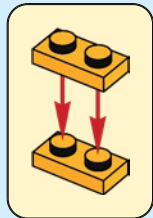

1x



1x

47

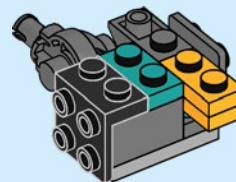

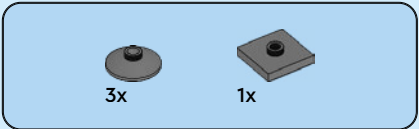

48

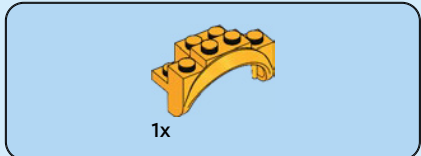
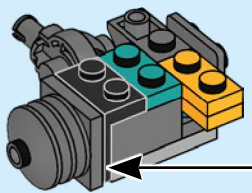
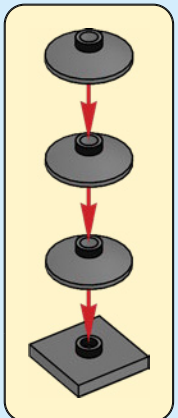

49

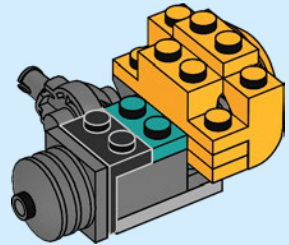

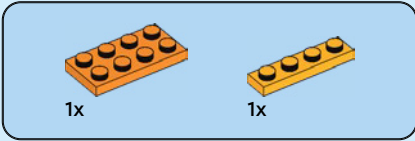
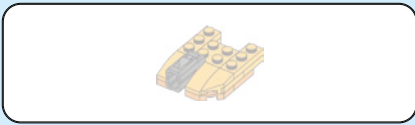

50

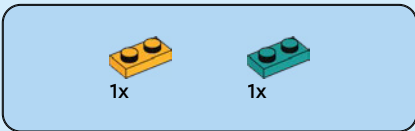
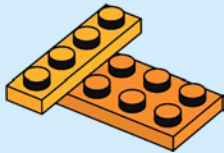

51

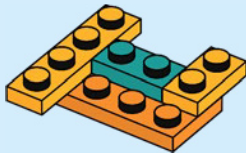

52

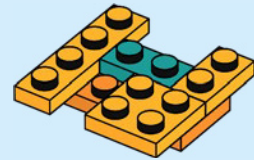

53

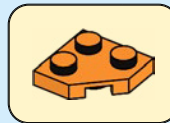
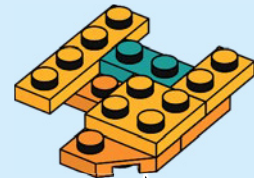



1x

54

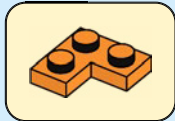
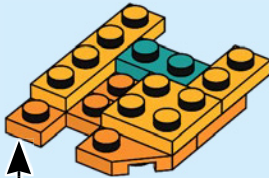

2x



1x

55

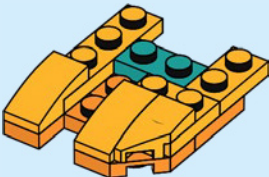

2x

56

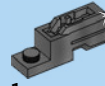
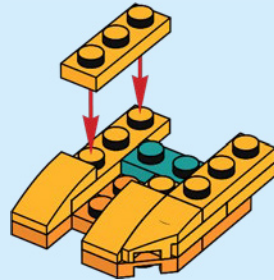

1x



1x

57

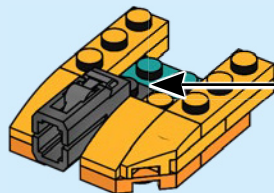
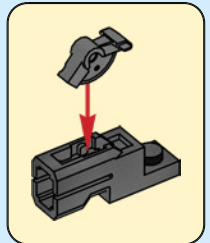



58

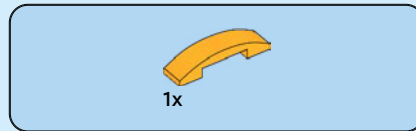
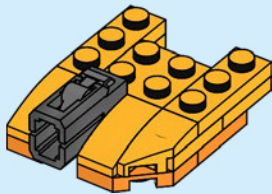

60

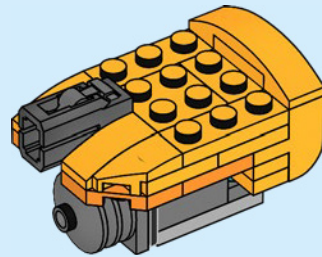

59

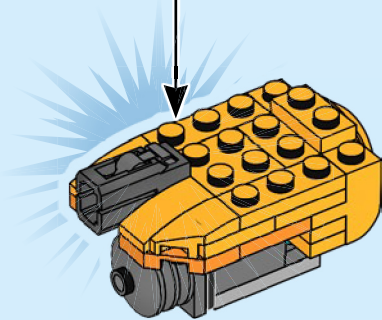

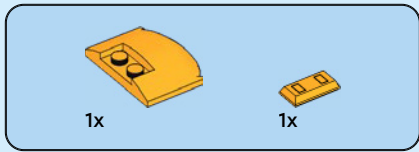

61

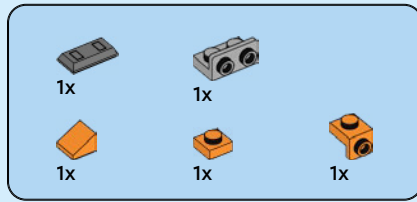
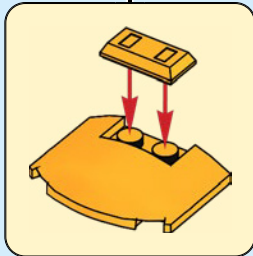
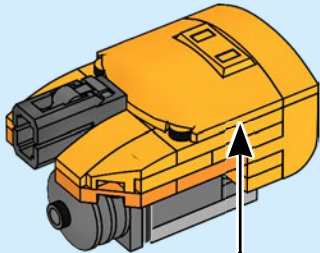

62

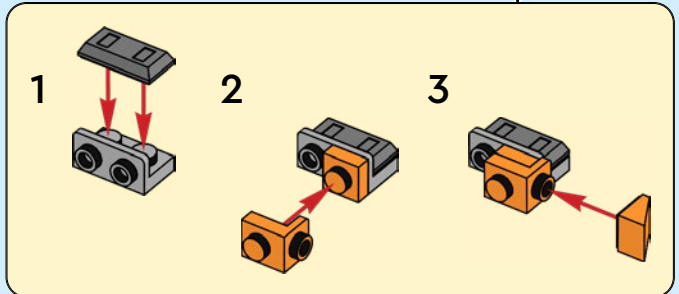
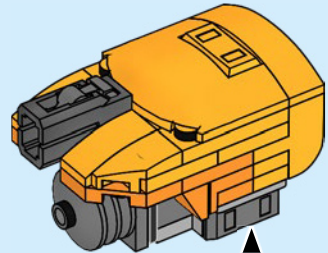

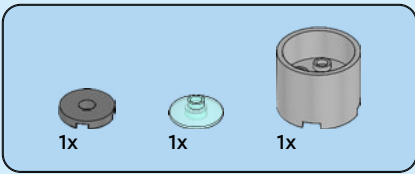

63

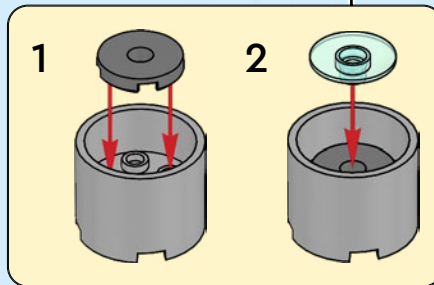
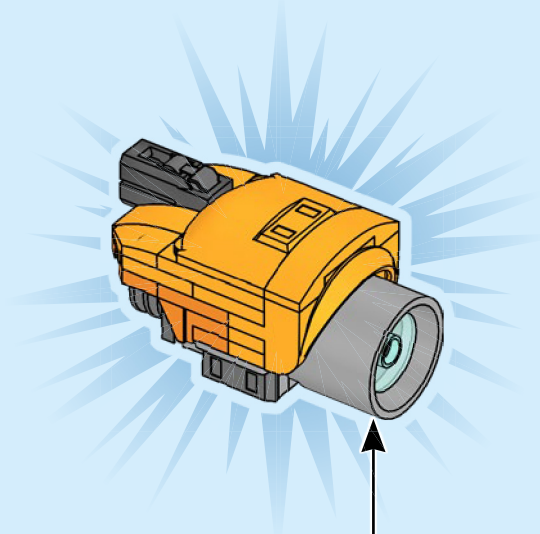

64

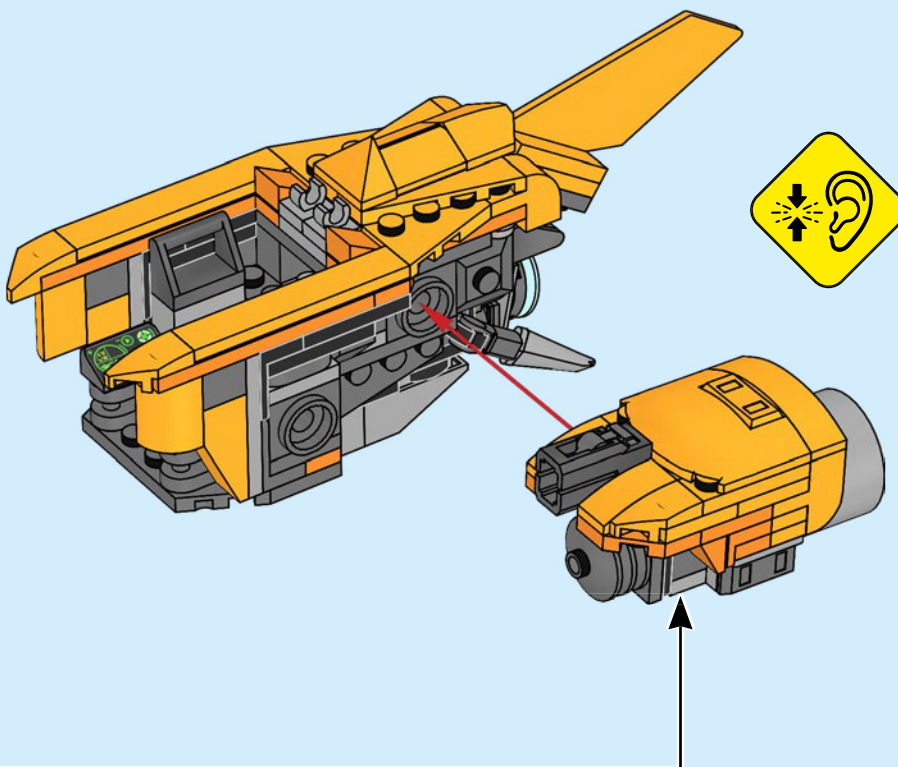

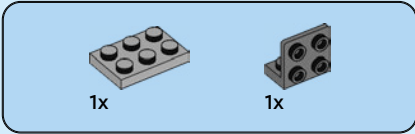
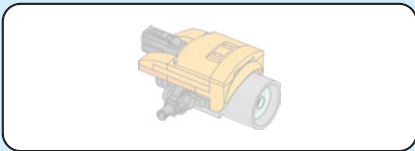

65

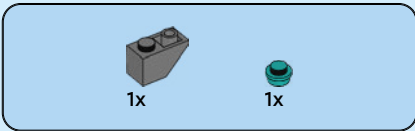
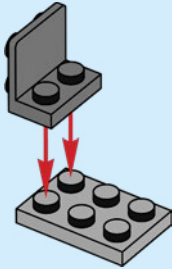

66

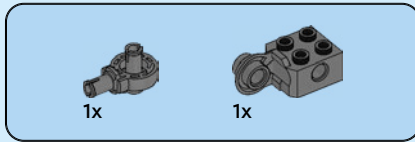
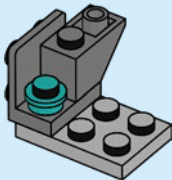

67

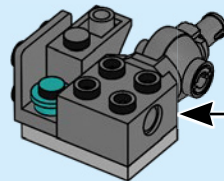
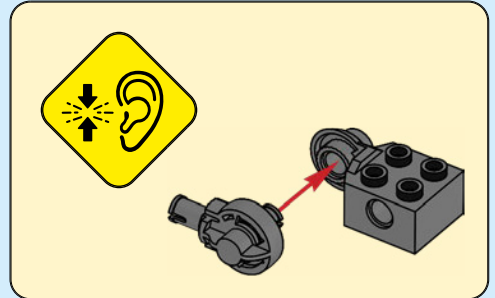



2x

68

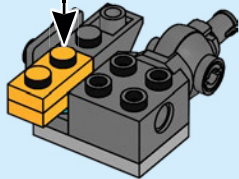
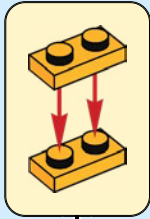

1x



1x

69

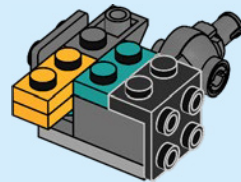

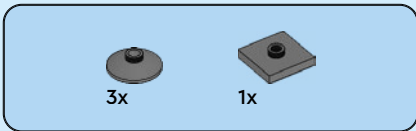

70

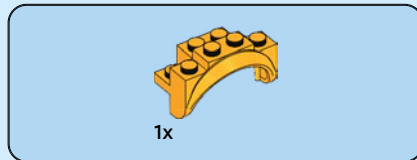
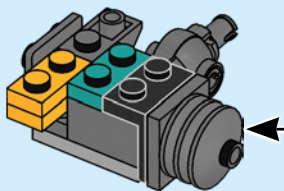
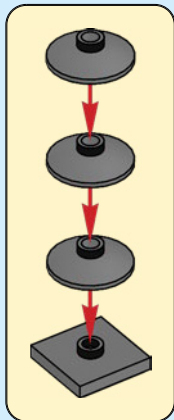

71

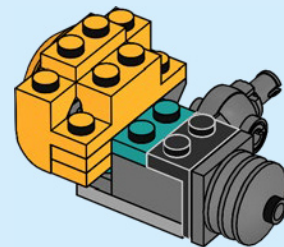

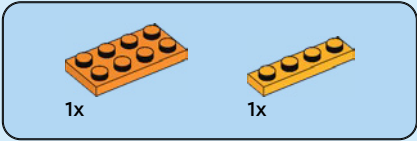
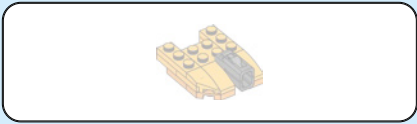

72

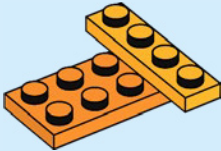

73

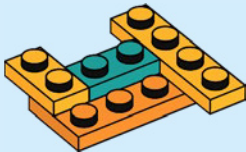

74

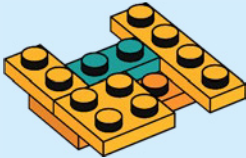

75

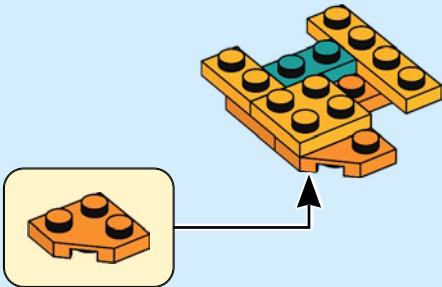

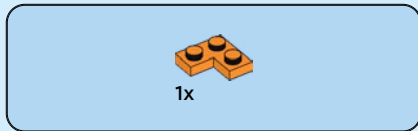

76

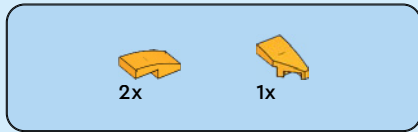
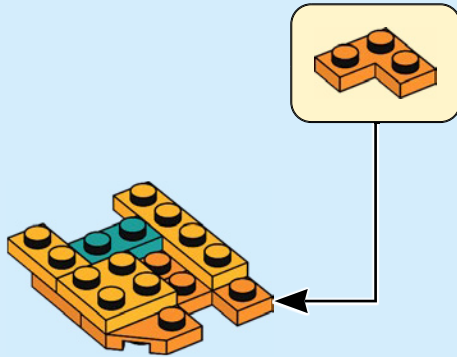

77

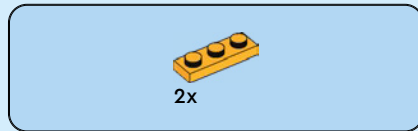
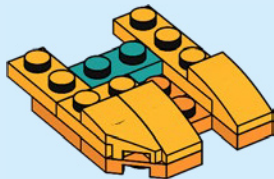

78

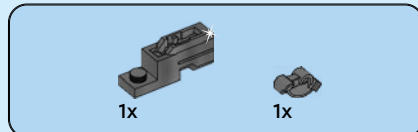
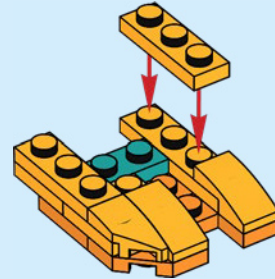

79

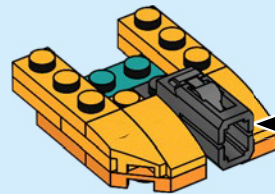
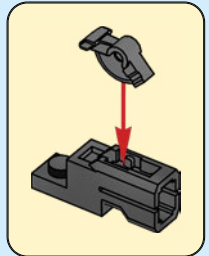



1x

80

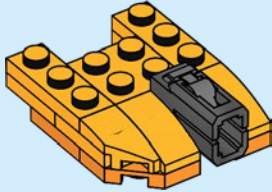

81

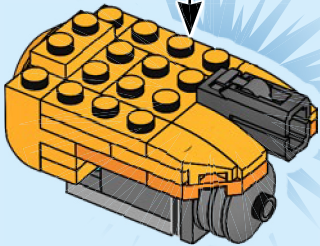

1x

82

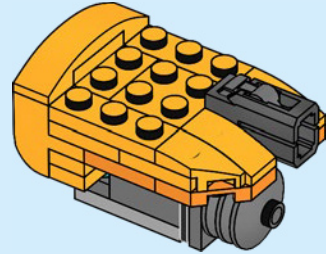

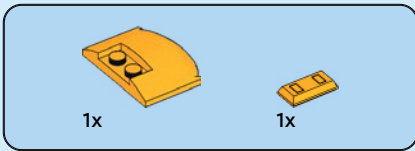

83

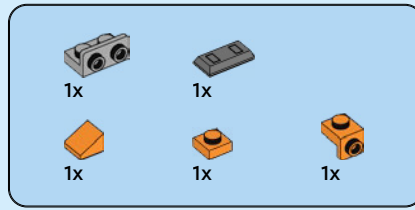
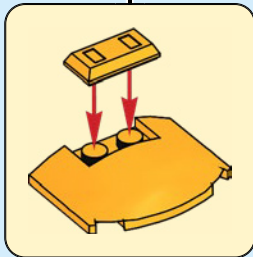
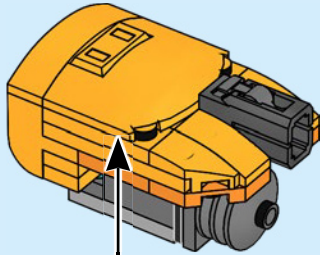

84

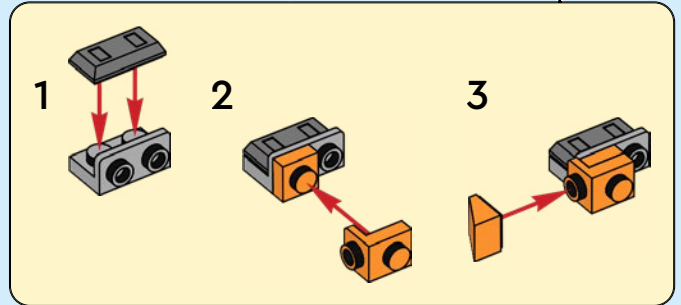
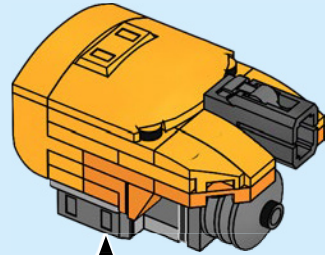

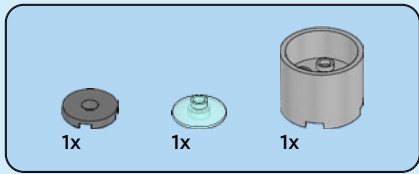

85

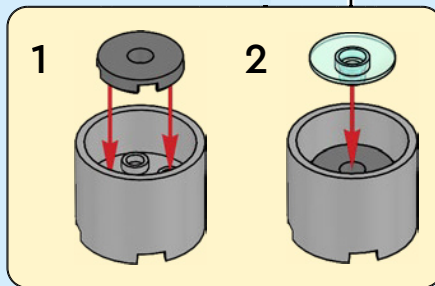
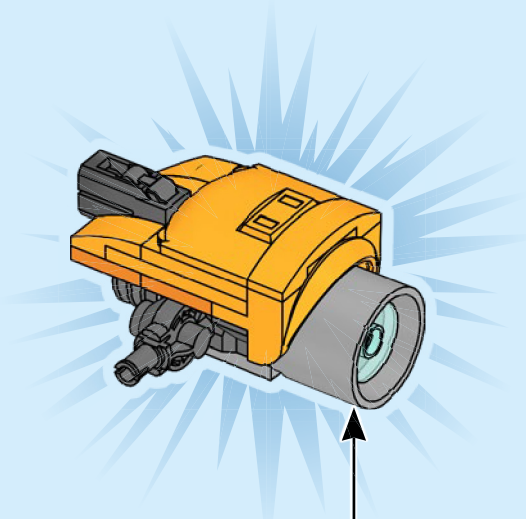

86

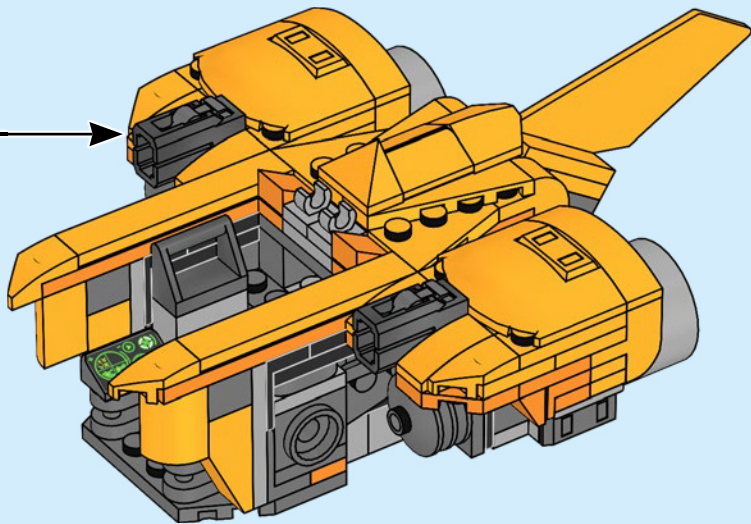

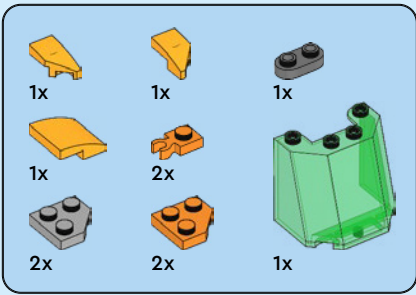

87

1

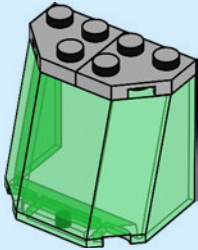

2



3



4

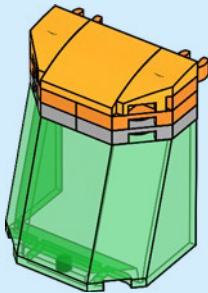

5

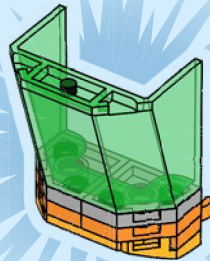

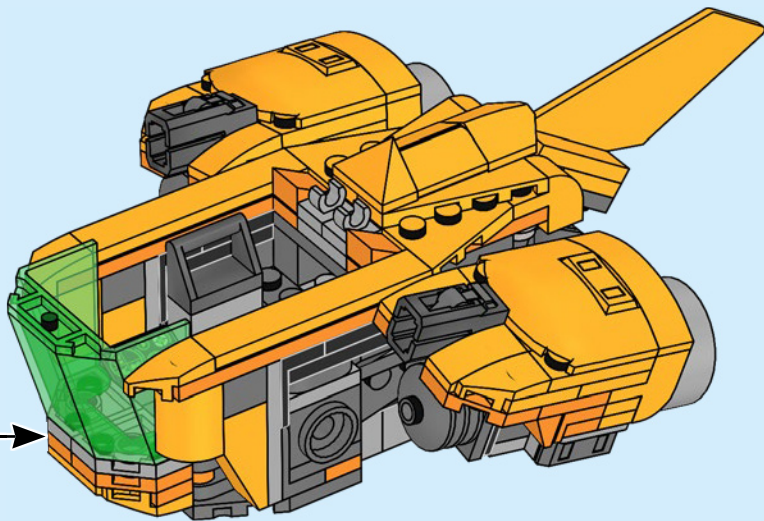

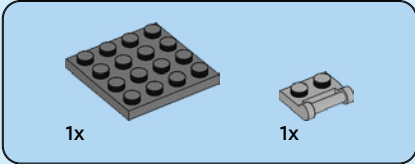
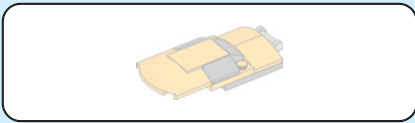

88

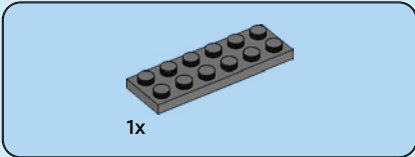
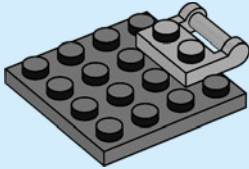

89

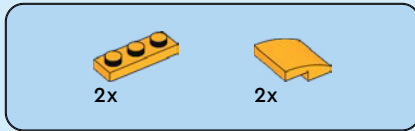
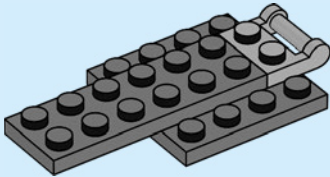

90

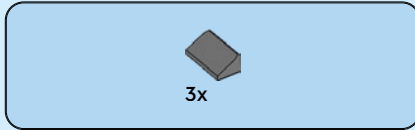
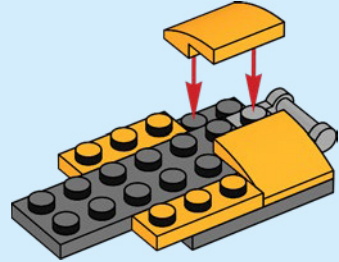

91

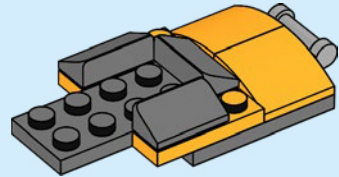



1x

92

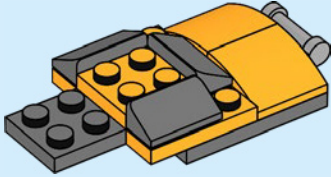

1x

93

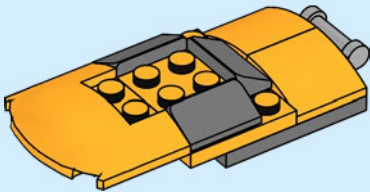

1x

94

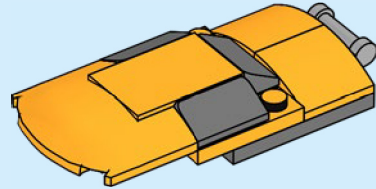

95

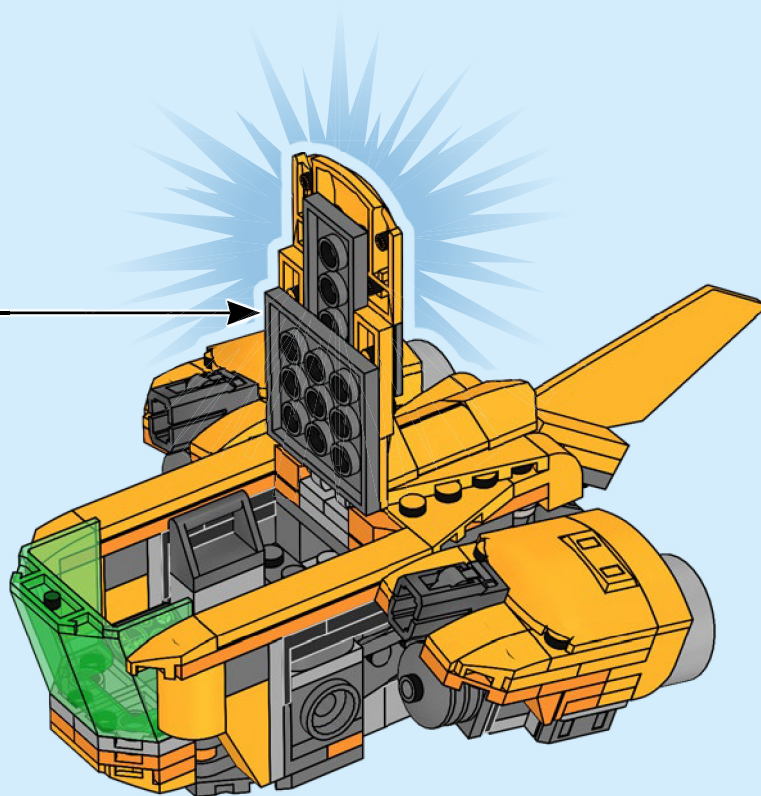

96

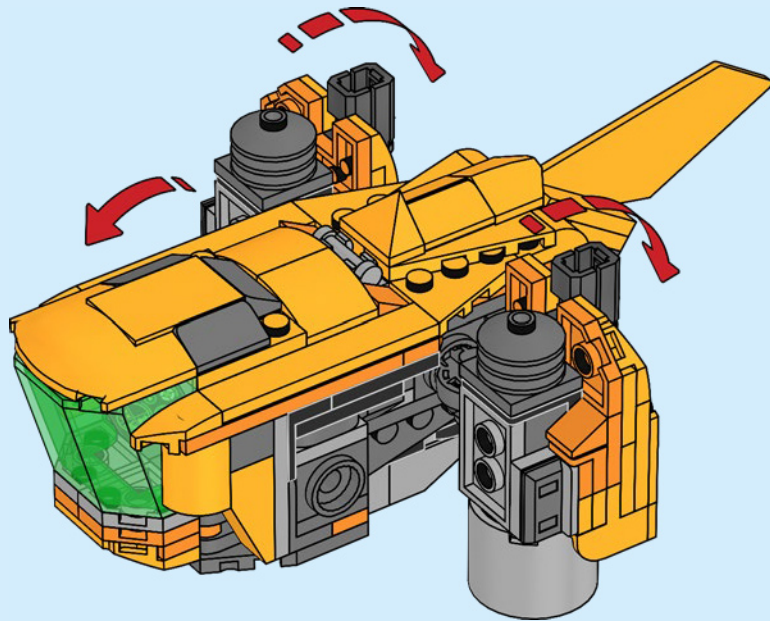



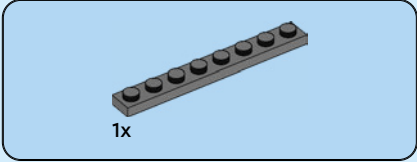
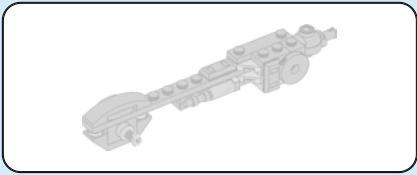

97

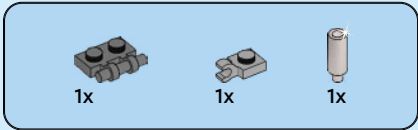
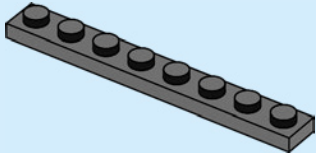

98

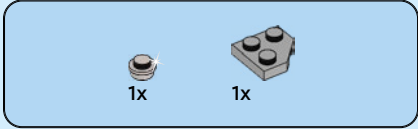
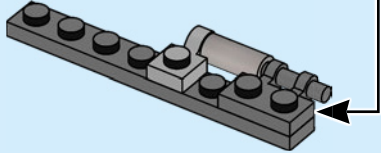
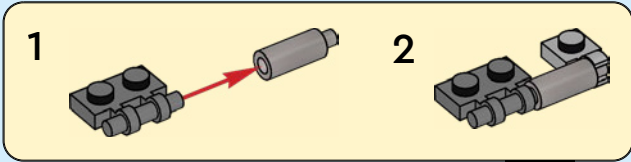

99

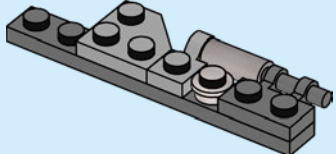

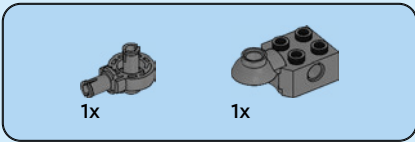

100

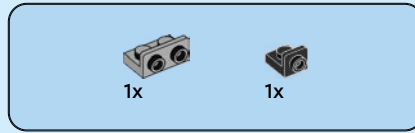
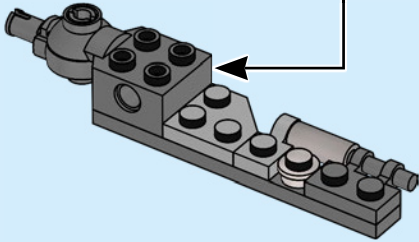
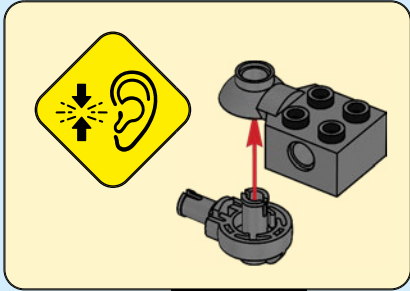

101

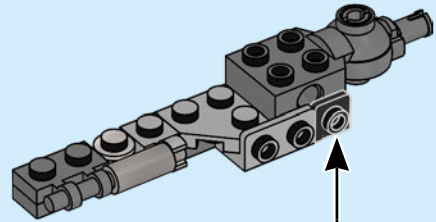
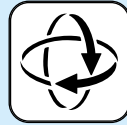

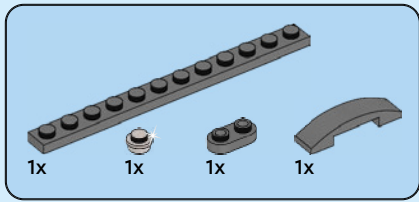

102

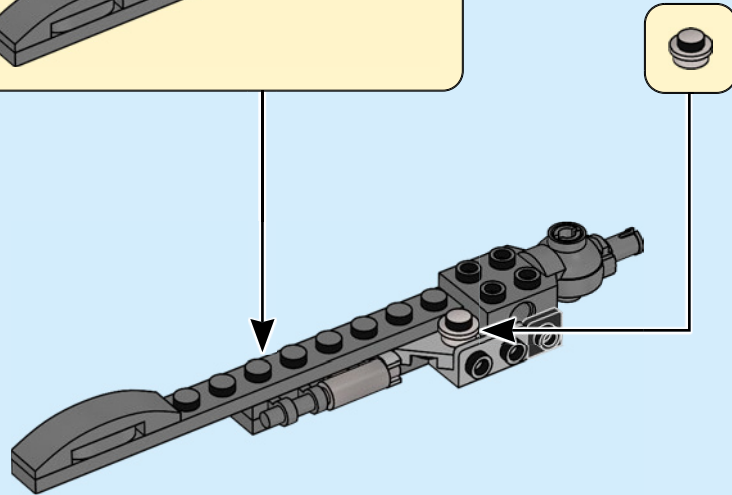
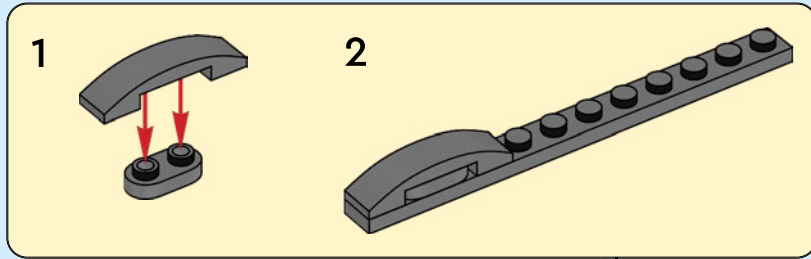



1x



1x

103

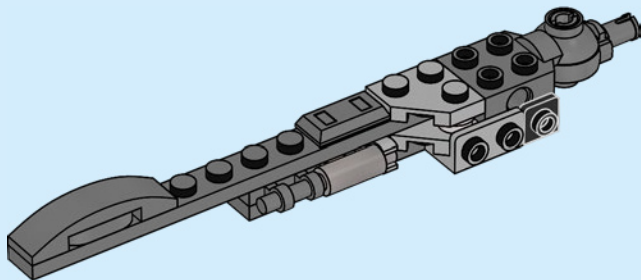

1x



1x



1x

104

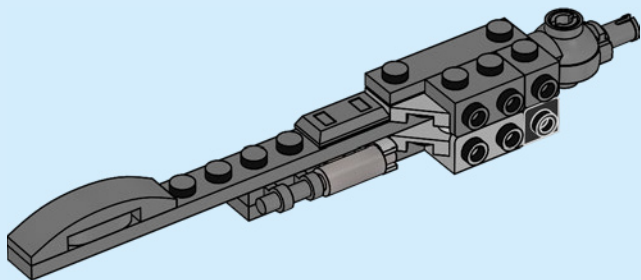

1x



1x

105

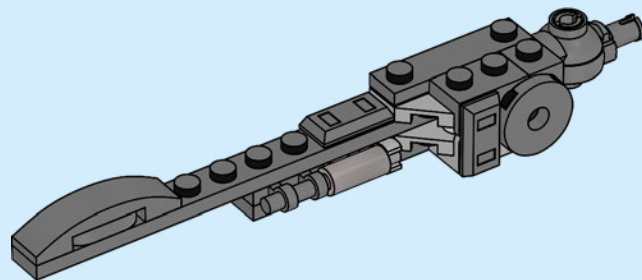

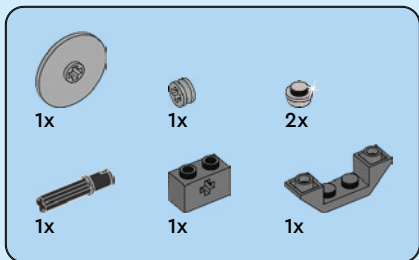

106

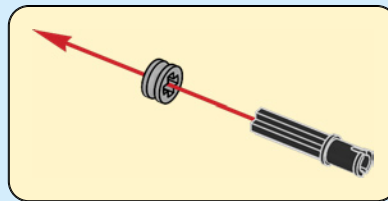

1

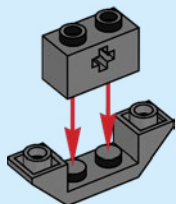

2

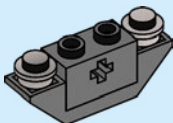

3

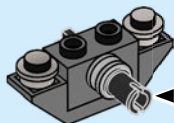

4

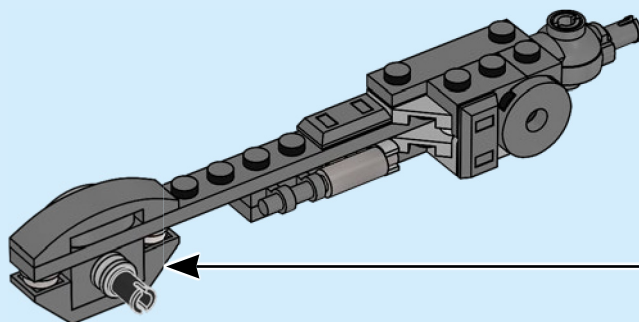
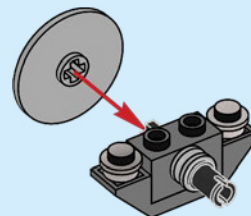

107

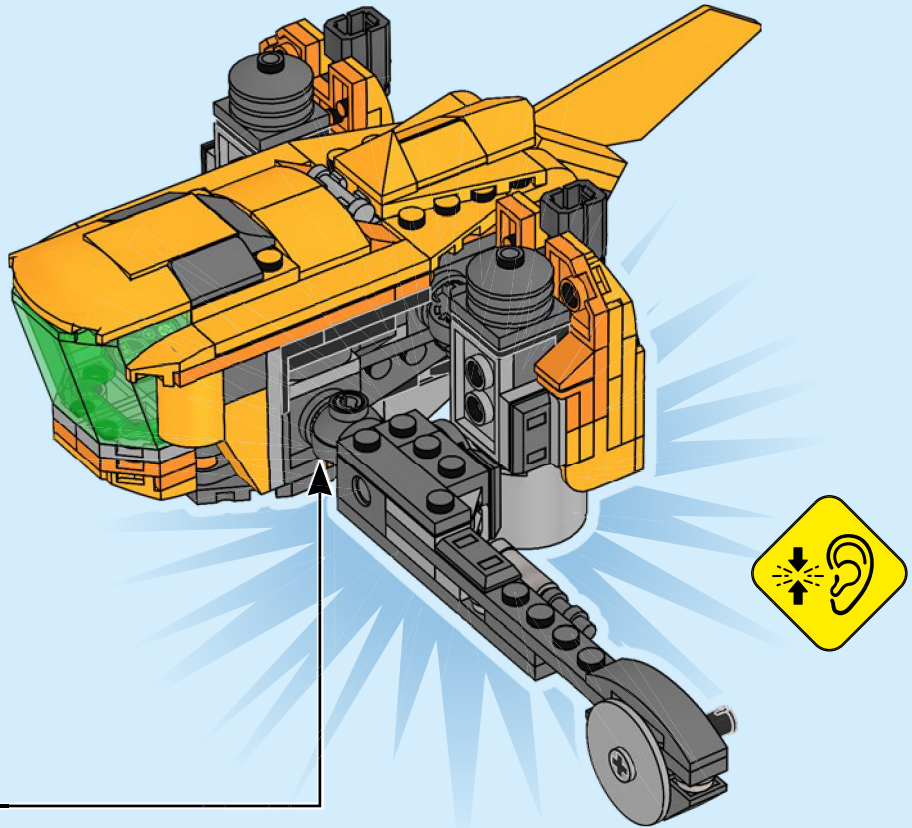

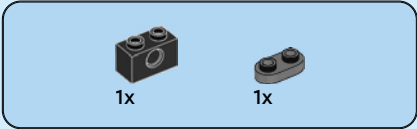

108

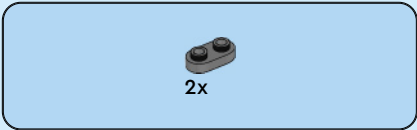
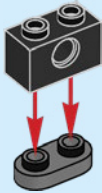

109

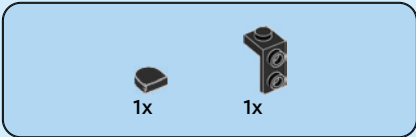
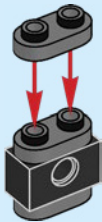

110

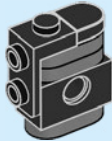

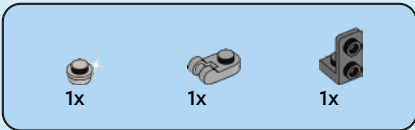

111

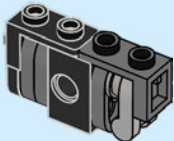
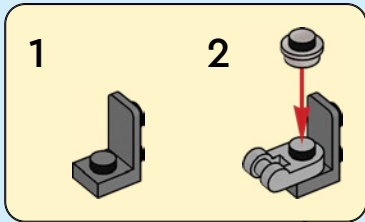

112

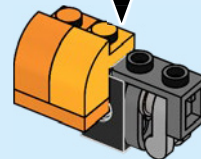
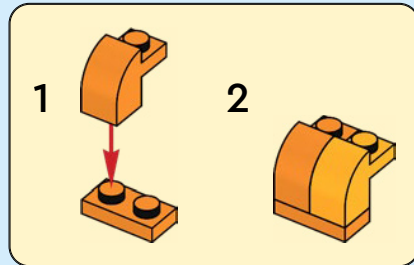



2x

113

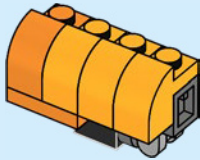

1x



1x

114

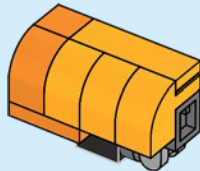

1x



1x



1x

115



1

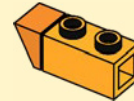

2

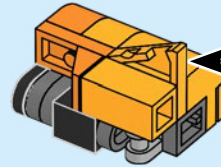
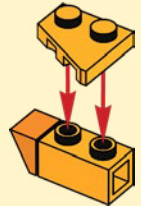

2x



1x

116

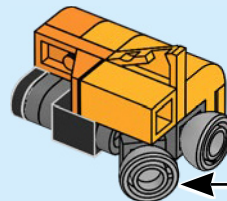

117

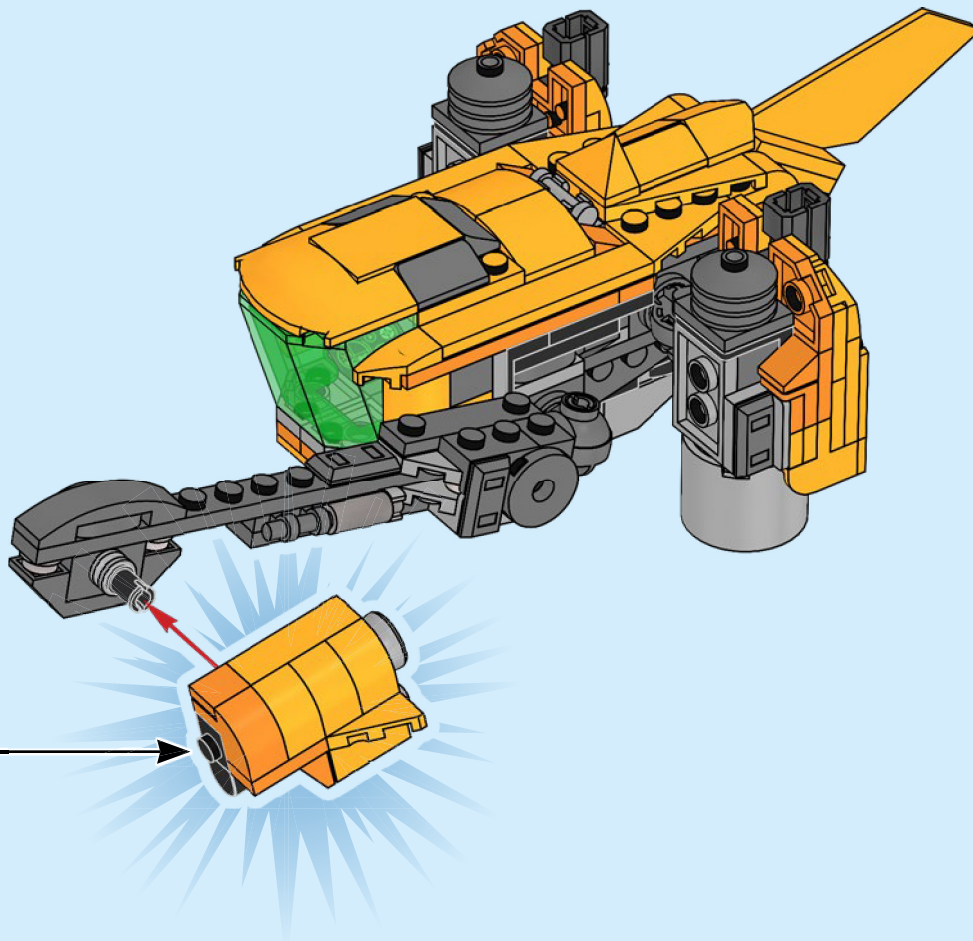

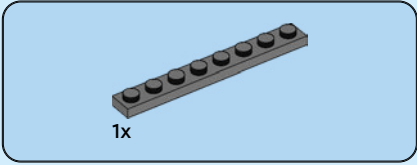
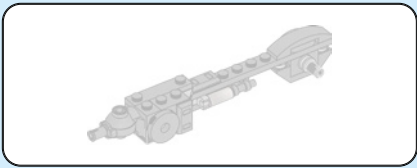

1x

118

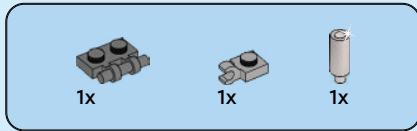
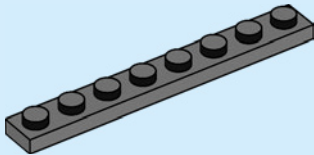

1x

1x

1x

119

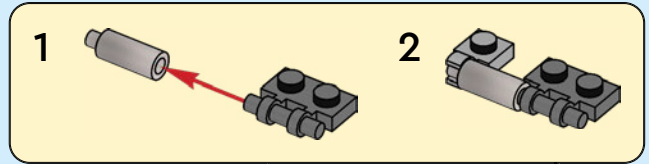

1

2

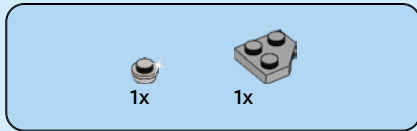
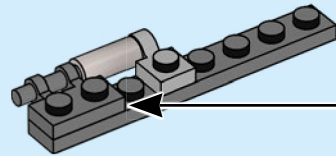

1x

1x

120

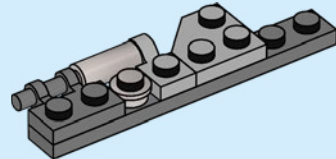

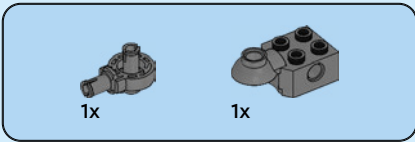

121

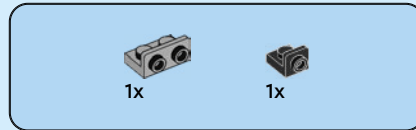
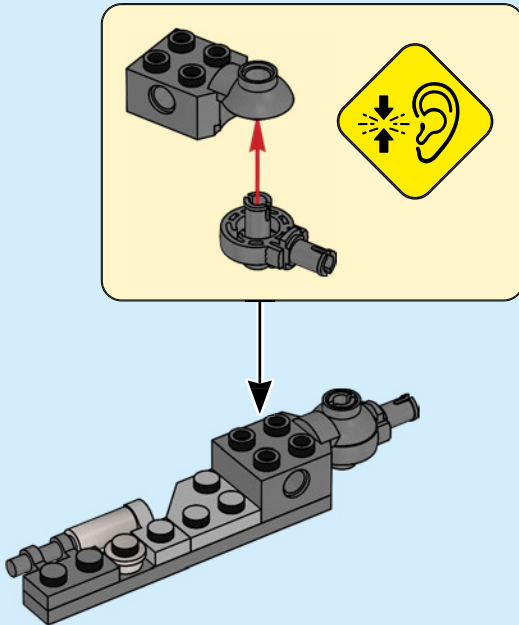

122

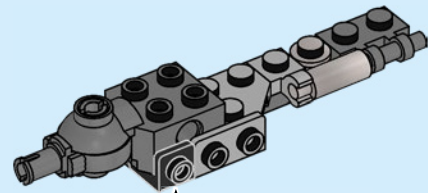
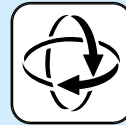

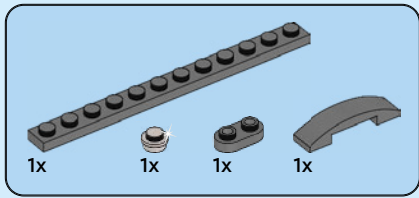

123

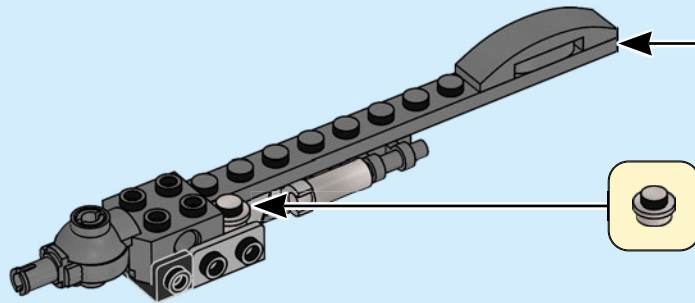
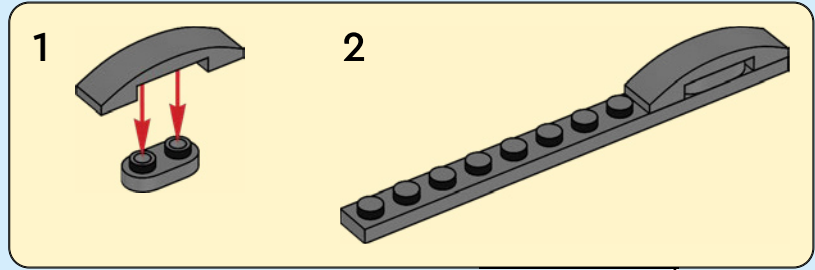



1x



1x

124

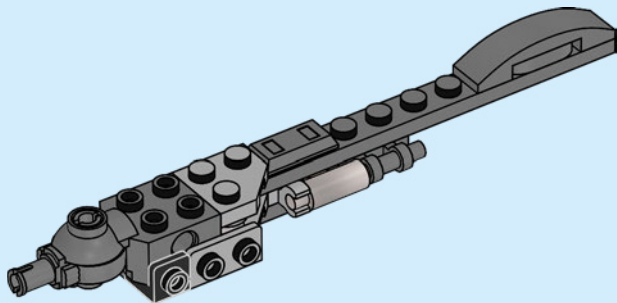

1x



1x



1x

125

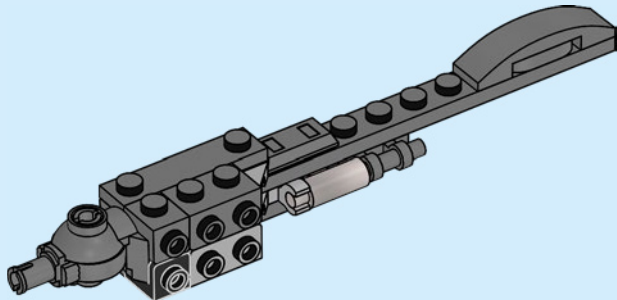

1x



1x

126

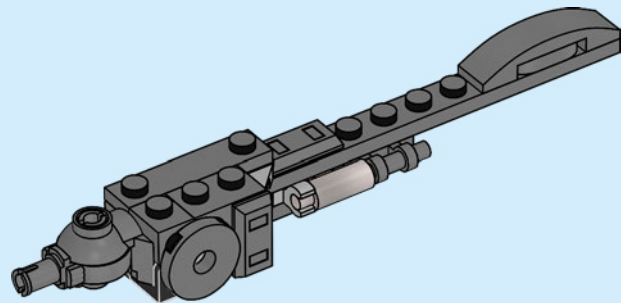

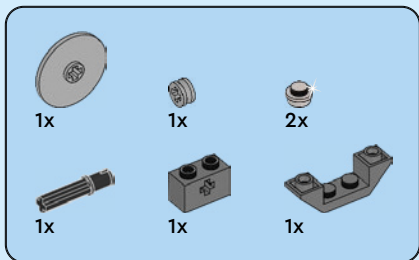

127

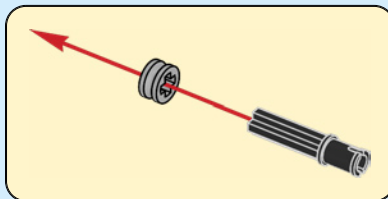

1

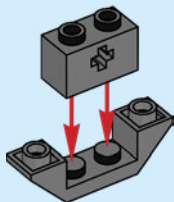

2

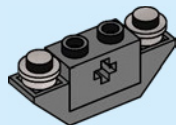

3

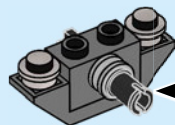

4

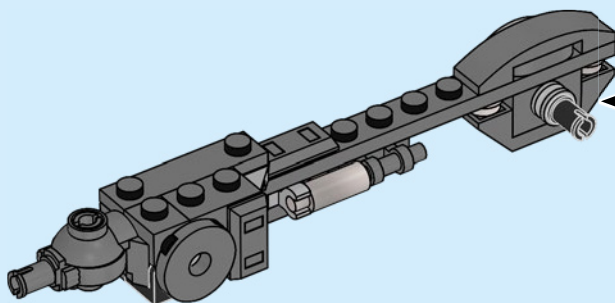
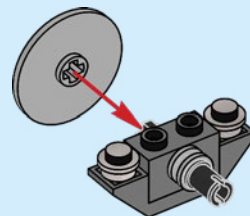

128

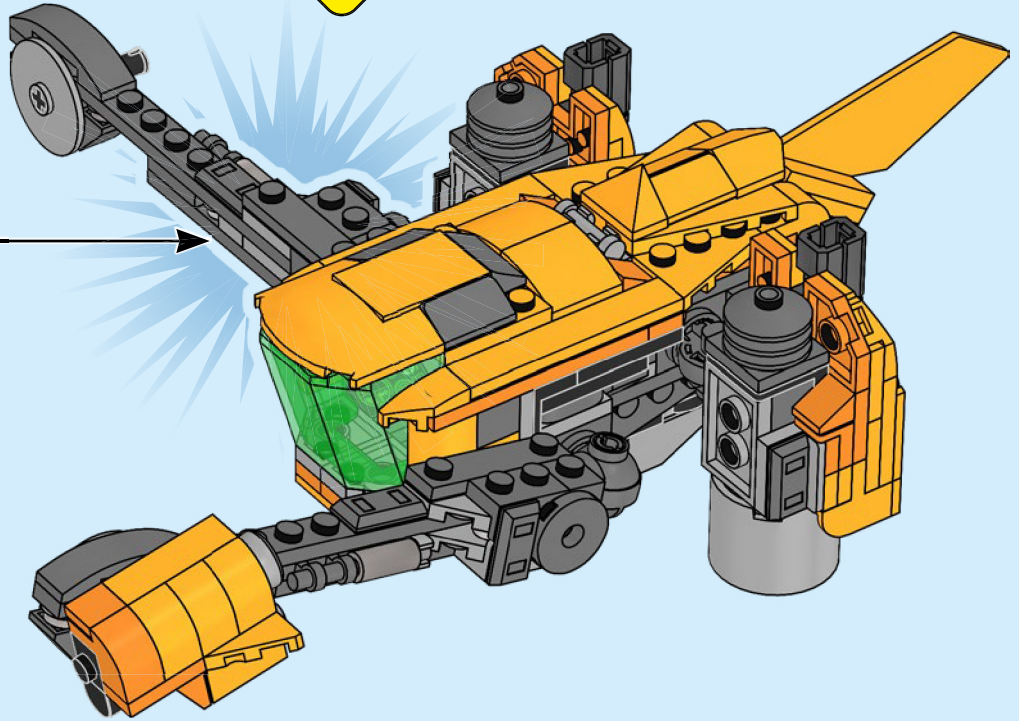

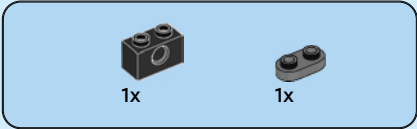

129

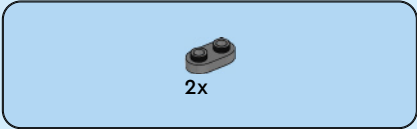
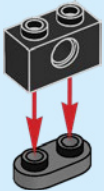

130

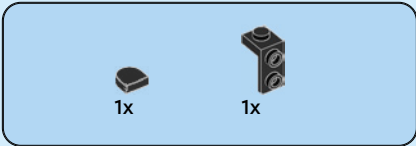
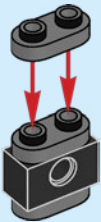

131

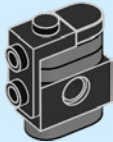



132

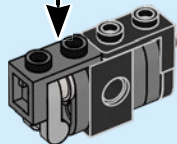
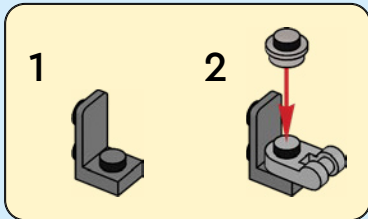

133

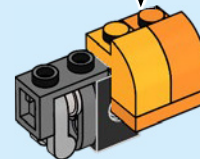
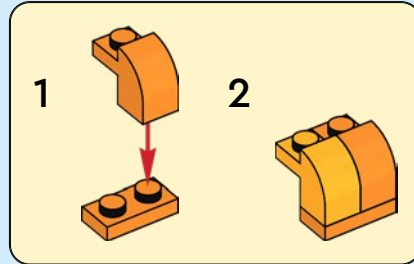



2x

134

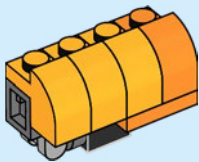

1x



1x

135

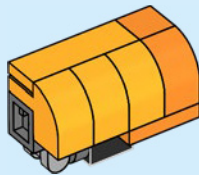

1x



1x



1x

136

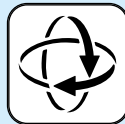

1



2

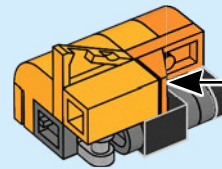
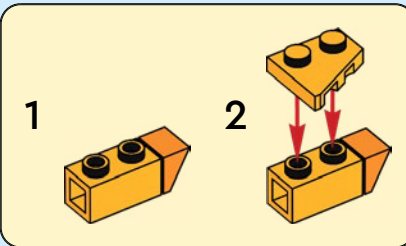
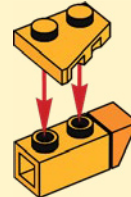

2x



1x

137

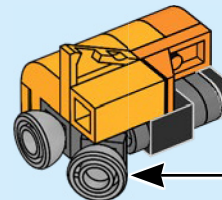

138

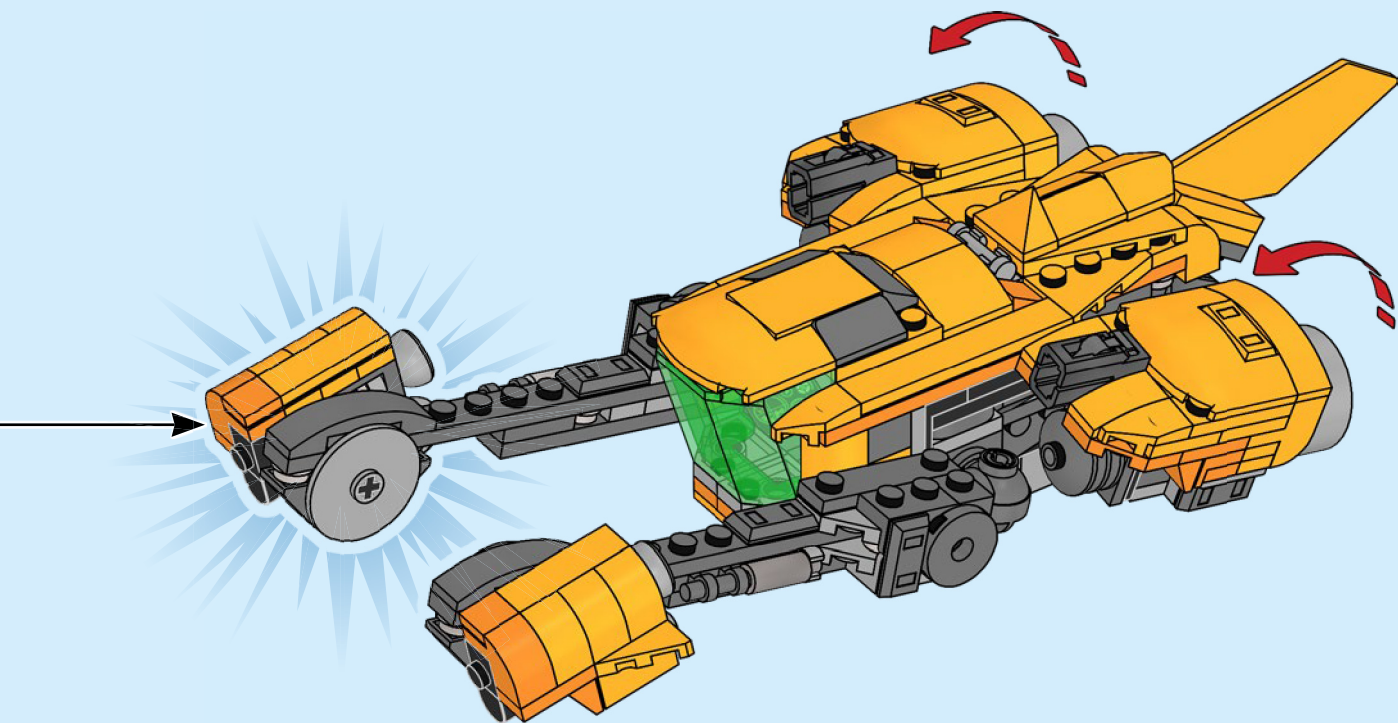



4x



139

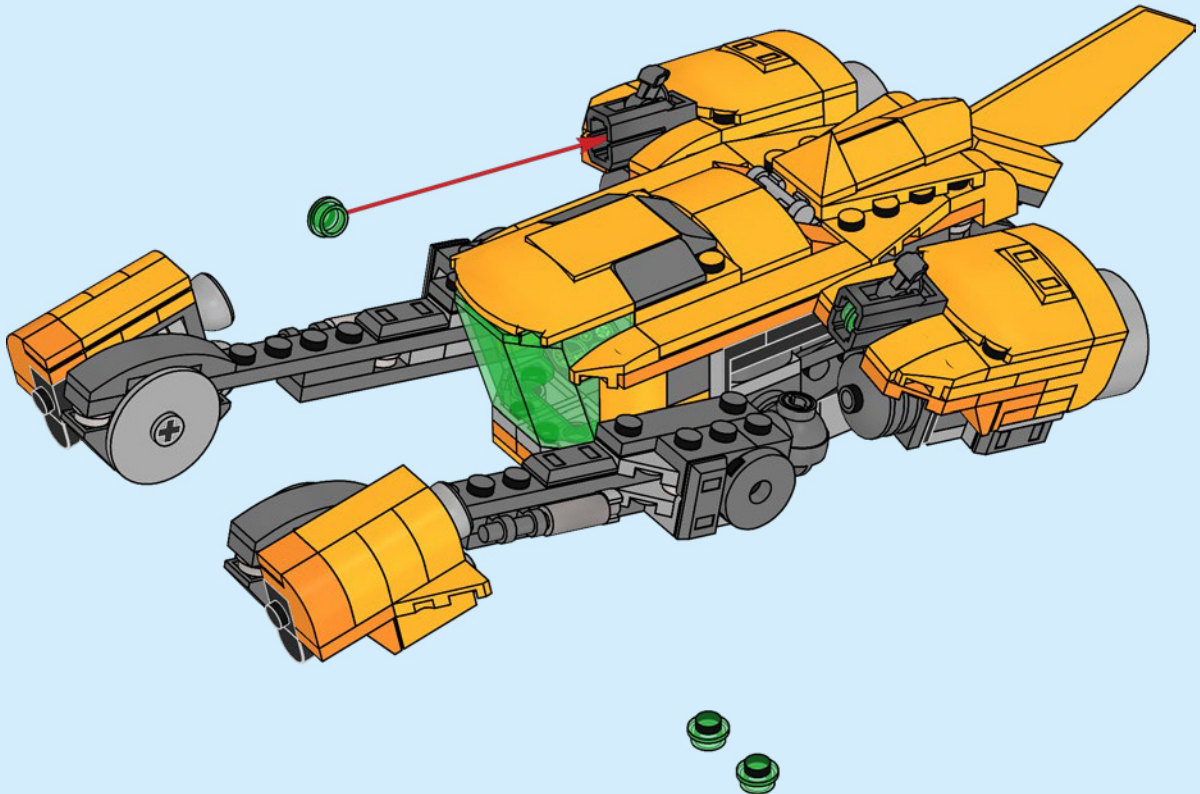

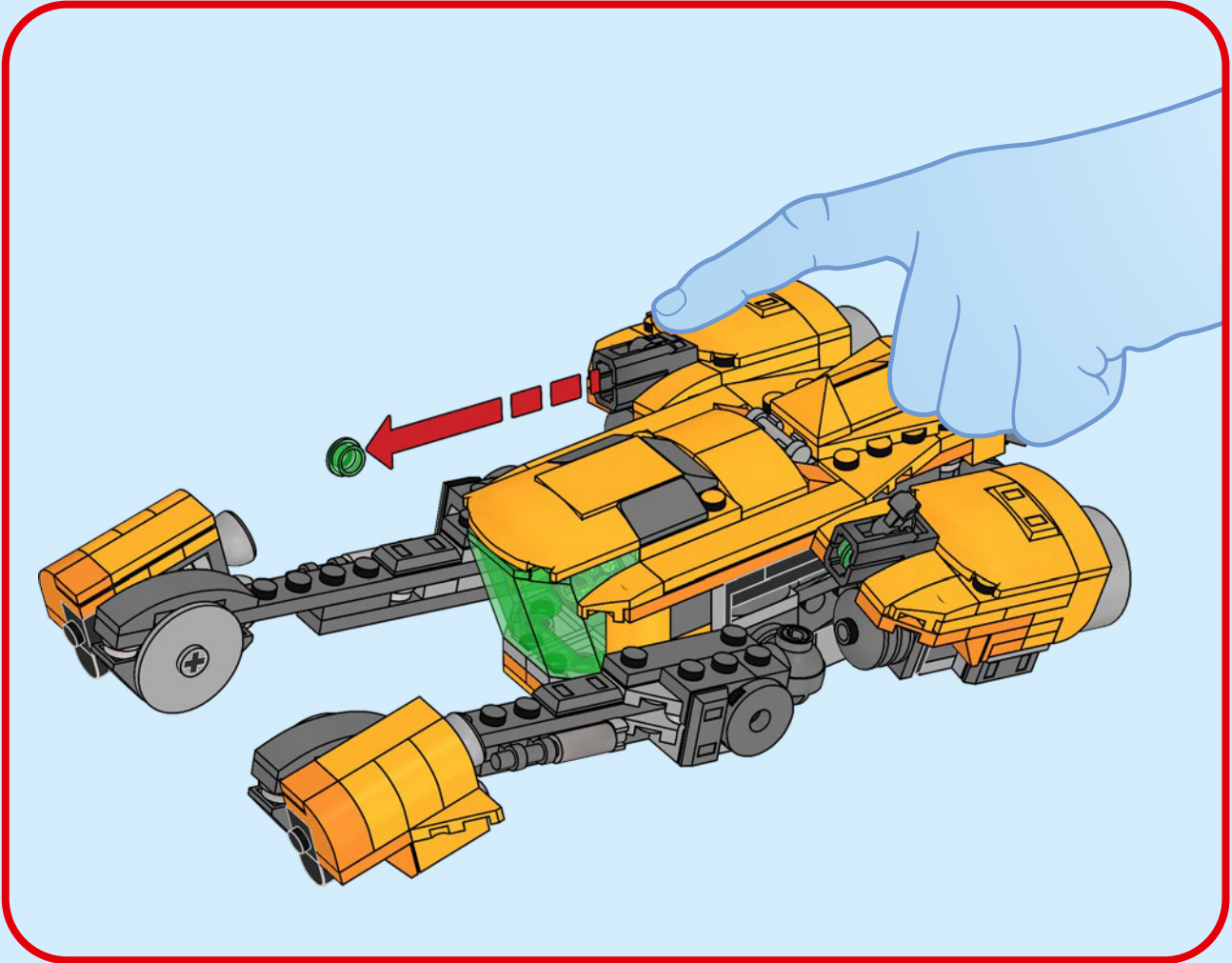

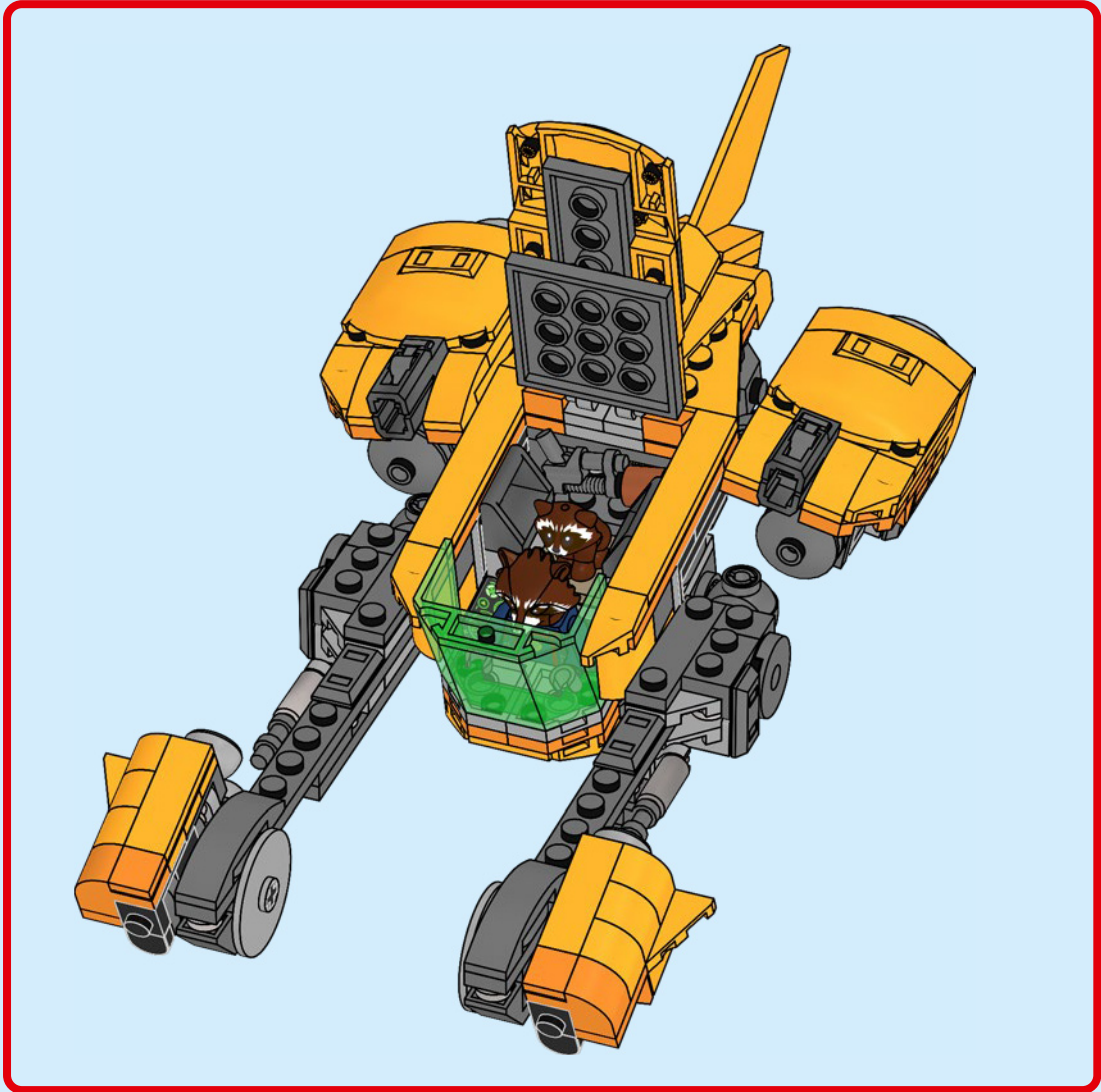



 2x 6278152	 2x 6325978	 1x 6227662	 6x 6073042	 2x 6326078	 2x 6347992
 2x 6256435	 4x 6213777	 1x 6020146	 2x 6099725	 6x 6186657	 4x 6221784
 4x 6380236	 1x 6249417	 3x 6289745	 1x 6286881	 4x 6004990	 2x 6353578
 2x 6234695	 1x 6126075	 2x 6024286	 2x 6020073	 2x 4667578	 2x 6225246
 2x 6336977	 1x 4530129	 1x 6382584	 3x 6218142	 1x 4244627	 1x 4278273
 3x 403226	 1x 6444438	 2x 6334836	 3x 6421680	 1x 4211881	 3x 4211396
 2x 370026	 3x 6289747	 7x 6028736	 2x 6421680	 2x 6267048	 3x 4211445
 6x 6117973	 2x 6328096	 2x 6236454	 2x 6365966	 2x 6270081	 1x 4211385
 2x 6089119	 1x 6296241	 4x 6099728	 1x 6307483	 2x 6326483	 4x 6240221
 4x 362326	 1x 6328059	 8x 6374487	 1x 6442581	 2x 6435930	 1x 6435795
 1x 302026	 1x 6020145	 1x 6400434	 1x 6404147	 2x 6271165	
 1x 6039194	 1x 6227663	 3x 6099730	 1x 6337817		
 3x 6245307		 6x 6003033			
74		 2x 6131583			

6x
4504371

2x
4524929

2x
4558595

2x
6403225

2x
6352223

6x
6218367

2x
6411362

2x
4177932

2x
6106027

2x
6147047

2x
4158355

3x
4173332

2x
6397633

4x
4211098

2x
6344022

2x
6360675

4x
6336390

2x
6413106

13x
6221607

2x
6390673

1x
4210782

2x
6214341

2x
6308045

1x
4210788

1x
4623236

2x
6194290

3x
4567887

6x
4211010

5x
6055313

4x
6398662

1x
4211066

7x
6331866

2x
4211096

2x
6178919

2x
4210660

4x
4522784

2x
6266225

2x
4210646

2x
4210635

2x
6126083

2x
4210725

2x
4648256

2x
6257592

2x
6185675

2x
6279898

2x
6343337

1x
4294180

3x
4243831

1x
4211002

1x
4521572

2x
4210998

2x
6133611

1x
6074890

2x
6336564

14x
4633691

3x
6158368

2x
6345952



 [LEGO.com/service](https://www.LEGO.com/service)

YOU COULD **WIN**



Scan this QR code or go to **LEGO.COM/PRODUCTFEEDBACK** and give us your short feedback about this LEGO® set for a chance to win a cool LEGO prize.

Terms and Conditions apply*

DE: Du könntest GEWINNEN. Es gelten die Teilnahmebedingungen* **FR: Tu pourrais GAGNER.** Des conditions s'appliquent* **IT: Potresti VINCERE tu.** Termini e condizioni sono applicabili* **ES: Puedes GANAR.** Aplican términos y condiciones* **PT: Poderá GANHAR.** Aplicam-se termos e condições* **JA: プレゼント付き! 利用規約が適用されます*** **ZH: 轻松获奖. 条款和条件适用*** **KO: 상품의 주인이 되어보세요. 소정의 약관이 적용됩니다*** **RU: Вы можете ВЫИГРАТЬ.** Действуют положения и условия* **PL: Szansa na WYGRANĄ.** Obowiązują warunki korzystania* **CS: Máte šanci VYHRÁT.** Platí všeobecné smluvní podmínky* **SK: Máte šancu VYHRAŤ.** Platia všeobecné zmluvné podmienky* **HU: TE IS NYERHETSZ.** Felhasználási feltételek érvényesek* **RO: Ai putea CÂȘTIGA.** Se aplică termeni și condiții* **BG: Можете да СПЕЧЕЛИТЕ.** Има определени правила и условия* **LV: Tu vari LAIMĒT.** Ir spēkā noteikumi un nosacījumi.* **ET: Sul on võimalus VÕITA.** Kehtivad tingimused* **LT: Jūs galite LAIMĖTI.** Taikomos sąlygos*

*LEGO.com/productfeedback-terms